

COUNTIS *E00/E02*

Single-phase energy meter
Direct - 40 A Pulse



COUNTIS E00



COUNTIS E02 - MID



1. DOCUMENTATION	3
2. HAZARDS AND WARNINGS	4
2.1. RISK OF ELECTROCUTION, BURNS OR EXPLOSION	4
2.2. RISK OF DAMAGING THE UNIT	4
2.3. RESPONSIBILITY	4
3. PRELIMINARY OPERATIONS	5
4. INTRODUCTION	6
4.1. INTRODUCING THE COUNTIS E00 / E02	6
4.2. FUNCTIONS	6
4.3. FRONT PANELS	6
4.4. LCD DISPLAY	7
4.5. DIMENSIONS	7
4.6. ELECTRICAL READINGS	8
4.6.1. MEASUREMENTS	8
5. INSTALLATION	9
5.1. RECOMMENDATIONS AND SAFETY	9
5.2. DIN RAIL MOUNTING	9
6. CONNECTION	10
6.1. CONNECTING THE COUNTIS E00/E02	10
6.2. CONNECTION TO THE ELECTRICAL NETWORK AND TO THE LOADS	10
7. MID COMPLIANCE	11
8. CONFIGURATION	12
8.1. ON-SCREEN CONFIGURATION	12
8.1.1. VIEW ALL OF THE MENU "SETUP"	12
8.1.2. DETAILED VIEW OF MENU "SETUP"	13
9. USE	14
9.1. DETAILED VIEW OF THE MAIN MENU	15
9.1.1. DETAILED VIEW OF THE PARTIAL ENERGY METER	16
9.1.2. STARTING UP THE PARTIAL ENERGY METER	16
9.1.3. STOPPING THE PARTIAL ENERGY METER	16
9.1.4. RESETTING THE PARTIAL ENERGY METER TO ZERO	17
10. DIAGNOSTICS MESSAGES	18
10.1. MALFUNCTION	18
11. ASSISTANCE	18
12. CHARACTERISTICS	19
13. GLOSSARY OF ABBREVIATIONS	21

1. DOCUMENTATION

All documentation on the COUNTIS E00 / E02 is available online at:
www.socomec.com/en/countis-e0x



2. HAZARDS AND WARNINGS

The term "device" used in the paragraphs below refers to the COUNTIS E00 / E02.

The assembly, use, servicing and maintenance of this equipment must only be carried out by trained, qualified professionals. SOCOMEC shall not be held responsible for failure to comply with the instructions in this manual.

2.1. Risk of electrocution, burns or explosion

- Only duly authorised and qualified personnel may work or install/uninstall the device.
- The instructions are valid together with the specific instructions for the device.
- The device is designed only for its intended purpose as set out in the instructions.
- Only accessories authorised or recommended by SOCOMEC may be used in association with the device.
- Before proceeding with installation, maintenance, cleaning, disassembly, connection, or maintenance work, the device and system must be cut off from the mains to avoid electrocution and damaging the system and device.
- This device is not designed to be repaired by the user.
- For any questions related to the disposal of the device, please contact SOCOMEC.

Failure to comply with the instructions of the device and this safety information can cause bodily injury, electric shock, burns, death or damage to property.

2.2. Risk of damaging the unit

To ensure that the unit operates correctly, make sure that:

- The unit is correctly installed.
- There is a maximum voltage at the voltage input terminals of 276 VAC phase-neutral
- The network frequency indicated on the device is observed: 50 or 60 Hz.
- a maximum current 40 A at the current input terminal.

Failure to respect these precautions could cause damage to the unit.

2.3. Responsibility

- Assembly, connection and use must be carried out in accordance with the installation standards currently in force.
- The unit must be installed in accordance with the rules given in this manual.
- Failure to observe the rules for installing this unit may compromise the device's intrinsic protection.
- The unit must be positioned within an installation which complies with the standards currently in force.
- Any cable which needs to be replaced may only be replaced with a cable having the correct rating.

3. PRELIMINARY OPERATIONS

To ensure the safety of staff and the equipment, it is vital to read and absorb the contents of these instructions thoroughly before commissioning.

Check the following points as soon as you receive the package containing the unit:

- The packaging is in good condition
- The unit has not been damaged during transportation
- The device reference number conforms to your order
- The package includes:
 - 1 device
 - 1 sealing kit (for COUNTIS E02)
 - 1 Quick Start guide

4. INTRODUCTION

4.1. Introducing the COUNTIS E00 / E02

The COUNTIS E00 and E02 are modular active and reactive electrical energy meters that display consumed energy. They are designed for single-phase networks and allow a direct connection of up to 40 A. They are equipped with a pulse output.

4.2. Functions

- Measures and displays total and partial energy
- Electrical parameter measurements: I, V, f
- Power, power factor
- Pulse output
- MID version (according to reference)

Description	Reference
COUNTIS E00	4850 3058
COUNTIS E02- Version MID	4850 3059

4.3. Front panels

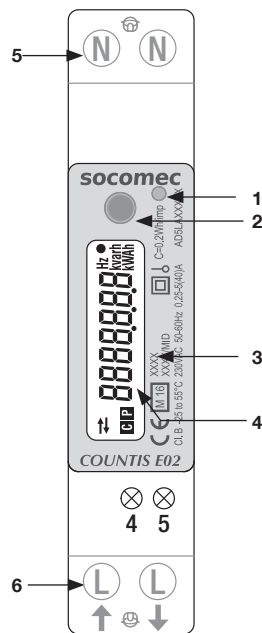
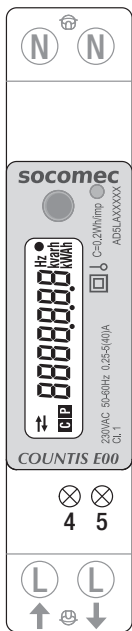

1. Metrological LED
2. ENTER key
3. Information relating to MID certification
4. LCD display
5. Neutral connection
6. Single-phase network connection

4.4. LCD display

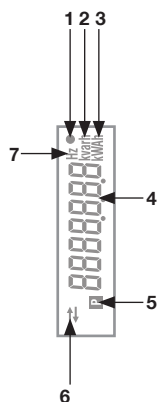

1. Active pulse output
2. Unit of measure
3. Unit of measure
4. Main zone (in the event of Code XX: metrological setting corrupt; return to manufacturer.)
5. Value of the partial meter Flashing = meter stopped
6. Imported (→) or exported (←) energy or power
7. Unit of measure

4.5. Dimensions

Dual dimensions : in/mm

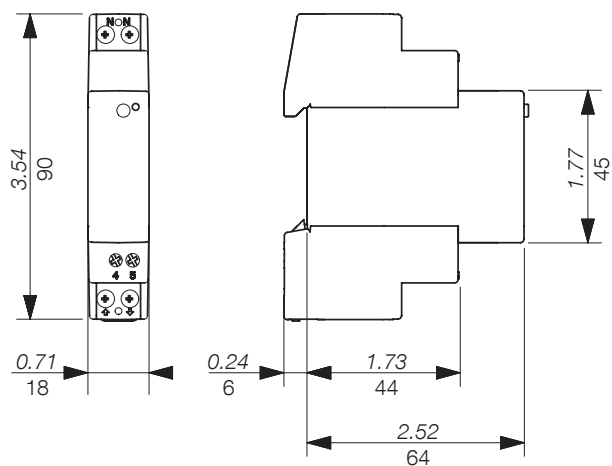

4.6. Electrical readings

4.6.1. Measurements

Settings vary by model.

Realtime values	Symbol	Unit of measure	LCD display
Neutral voltage	V	V	●
Current	I	A	●
Power factor	PF		●
Active power	P	kW	●
Reactive power	Q	kvar	●
Frequency	f	Hz	●
Direction of current	↻		●
Logged data			
Total active and reactive energy	Ea, Er	kWh, kvarh	●
Partial active and reactive energy	Ea, Er	kWh, kvarh	●
Miscellaneous			
Partial meters	P	START/STOP	●
Status of the pulse output	●	Active / inactive	●

5. INSTALLATION

The paragraphs below describe how to install the device.

5.1. Recommendations and safety

Refer to the safety instructions (section "2. Hazards and warnings", page 4)

- Keep away from electromagnetic interference generator systems,
- Avoid vibrations with accelerations greater than 1 g for frequencies lower than 60 Hz.

5.2. DIN rail mounting

The COUNTIS E00/E02 can be mounted on a 35-mm DIN rail (EN 60715TM35). They must be used inside electrical cabinets.

6. CONNECTION

6.1. Connecting the COUNTIS E00/02

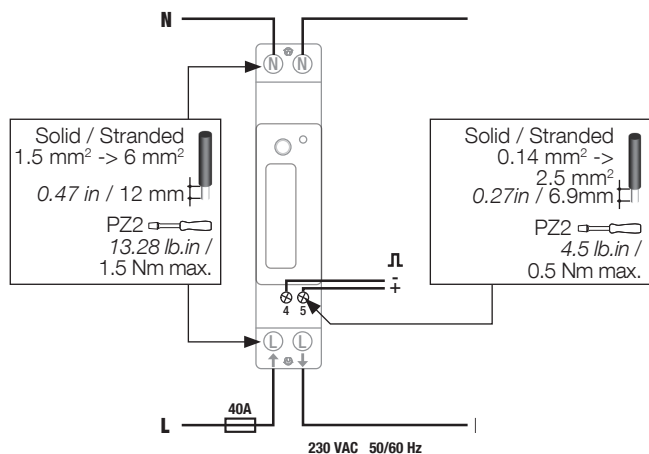

6.2. Connection to the electrical network and to the loads

The COUNTIS E00/E02 are intended for single-phase networks with neutral.

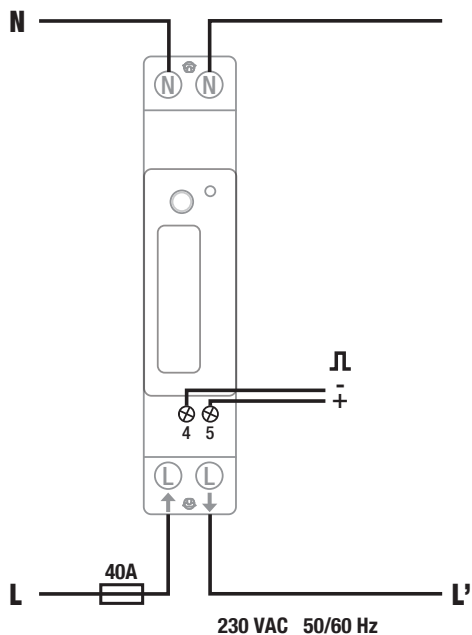

Pulse output

4: -
5: +

Optocoupler pulse outputs

Terminals 4-5 must be supplied with voltage between 5 and 27 VDC (27 mA max)

Network

L: ↑ : Phase input

L': ↓ : Phase output

N: Neutral connection

7. MID COMPLIANCE

The following points must be taken into consideration to ensure that the device is used in compliance with directive MID 2014/32/EU:

- **Type of network**

COUNTIS E02 meters comply with the MID directive for connection to networks: 1P+N (see "6.2. Connection to the electrical network and to the loads", page 10)

- **Fitting terminal covers**

After connecting the device, ensure that the terminal covers are fitted properly and secured by the plastic seals provided with the device.

- **MID Declaration of Conformity**

The MID Declaration of Conformity is available on the website: www.socomec.com/en/countis-e0x

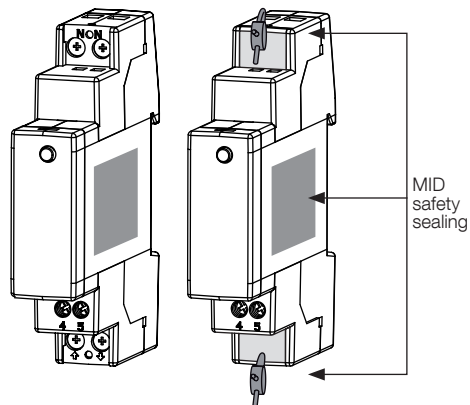

8. CONFIGURATION

The device can be configured directly from the COUNTIS E00/E02 screen in programming mode. The paragraphs below describe configuring using the screen.

8.1. On-screen configuration

From the screen, go to programming mode to reset partial energy to zero. How to browse through the programming mode is described in the following stages:

Function	Where	Buttons	Press
Switch pages within a menu	Every page within a menu		Realtime
Go to SETUP menu	Menu page SETUP		> 3 sec
Exit SETUP menu	SAVE screen from the SETUP menu		> 3 sec
Start/stop the displayed partial meter	Partial meter menu		> 3 sec
Reset the displayed partial meter to zero	Partial meter menu		> 3 sec

8.1.1. View all of the menu "SETUP"

In the SETUP menu, press " " for 3 seconds to put the device into programming mode.

Press " " to go to the different screens:

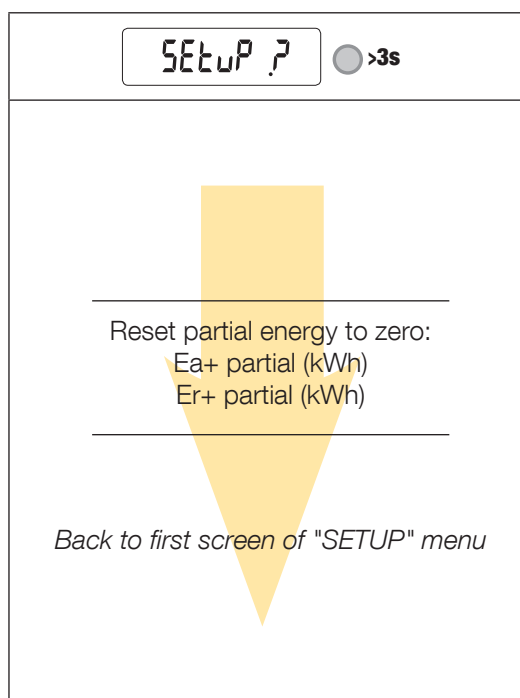

8.1.2. Detailed view of menu "SETUP"

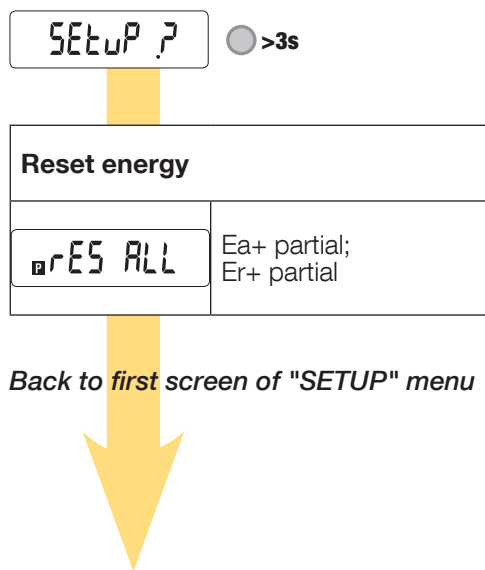

9. USE

The electric measurements or information is/are accessible by pressing the "●" button once.

The associated measurements are described in the table below:

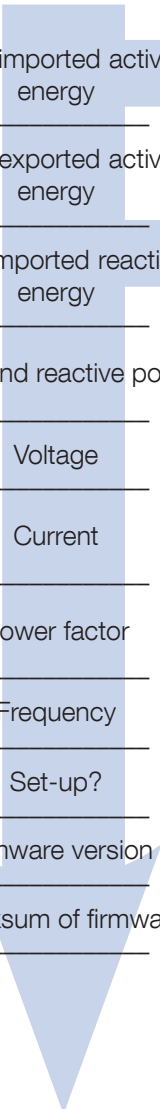

Total imported active energy	● >3 sec	Partial imported active energy
Total exported active energy		
Total imported reactive energy	● >3 sec	Partial imported reactive energy
Active and reactive power		
Voltage		
Current		
Power factor		
Frequency		
Set-up?		
Firmware version		
Checksum of firmware		

9.1. Detailed view of the Main menu

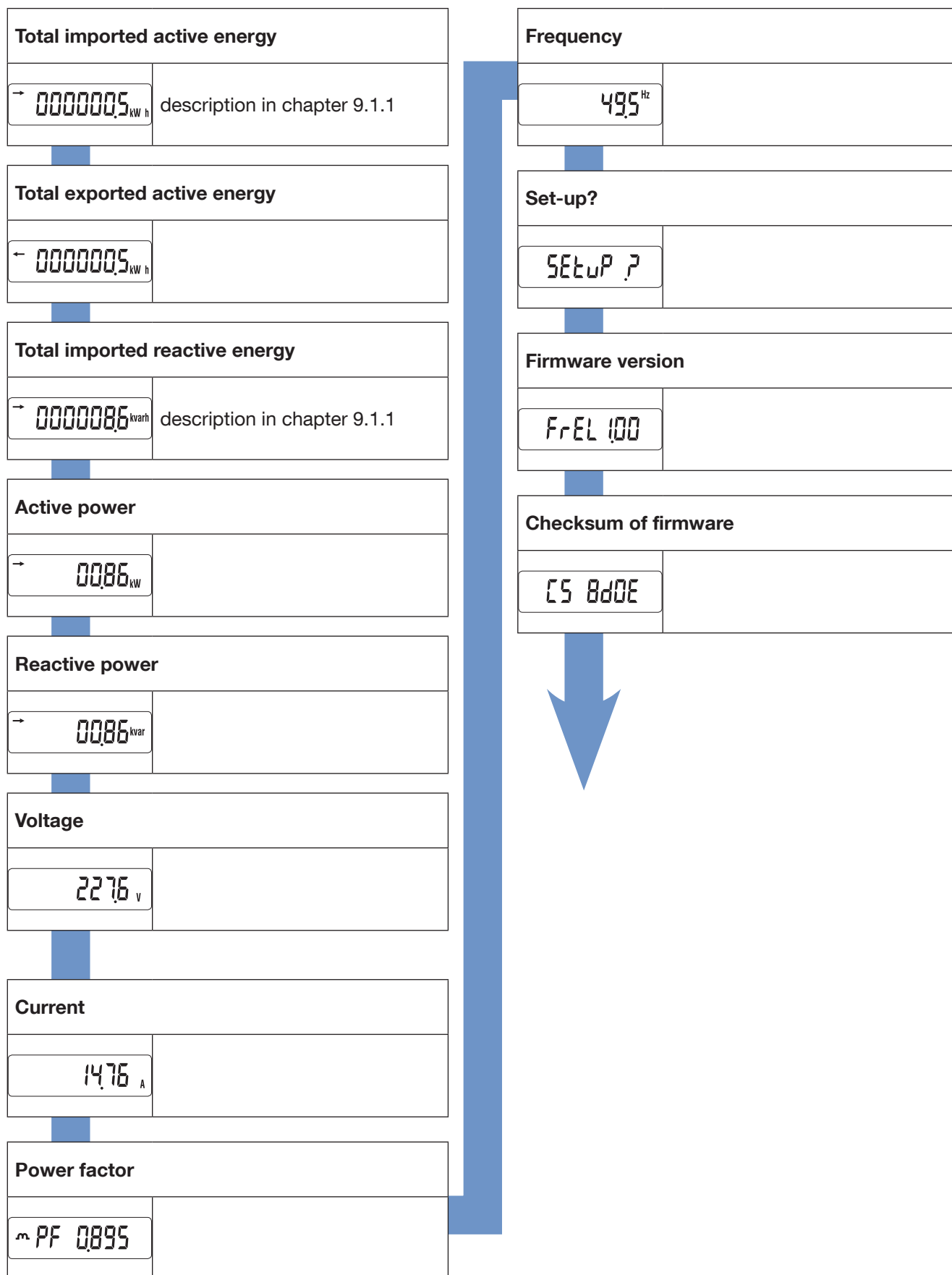

9.1.1. Detailed view of the partial energy meter

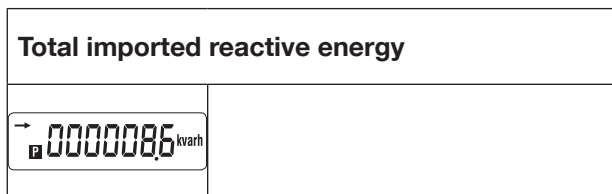
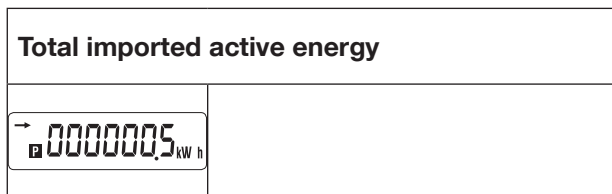

9.1.2. Starting up the partial energy meter

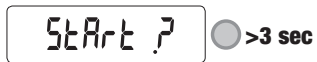

9.1.3. Stopping the partial energy meter



9.1.4. Resetting the partial energy meter to zero

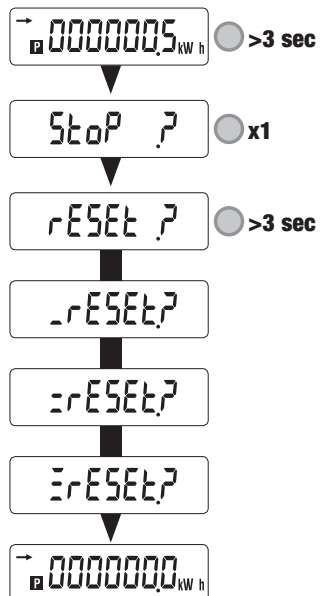

10. DIAGNOSTICS MESSAGES

The following message appears if there are connection or malfunction errors.

10.1. Malfunction

CODE

- When messages with the code xx are displayed, the meter has malfunctioned and must be replaced.

11. ASSISTANCE

Causes	Solutions
Device not working	Check the neutral and phase cable connections
Error message	Check the meter is working OK

12. CHARACTERISTICS

GENERAL FEATURES	
Compliant with	European EMC Directive No. 2014/30/EU dated 26/02/2014 LV Directive No. 2014/35/EU dated 26/02/2014 Measuring Instrument Directive MID No. 2014/32/EU dated 26/02/2014 EN50470-1/-3 IEC 62053-21/-23
Frequency	45 and 65 Hz
Power supply	Self-supplied
Rated dissipated power (Wmax.)	1.5 VA - 1 W
FEATURES	
Single-phase connectivity	2 wires 230 V
Stores energy readings and settings	In the EEPROM memory
CURRENT MEASUREMENTS	
Type	Single-phase - direct 40 A
Input consumption	0.5 VA
Start-up current (Ist)	0.02 A
Minimum current (Imin)	0.25 A
Transition current (Itr)	0.5 A
Reference current (Iref)	5 A
Permanent overload (Imax)	40 A
Intermittent overload	30 Imax for 1/2 cycle
OVERLOAD CAPACITY	
Continuous voltage Un	276 VAC
Realtime voltage Un (1 s)	300 VAC
Continuous current Imax	40 A
Realtime current Imax	30 Imax for 1/2 cycle
VOLTAGE MEASUREMENTS	
Range of measurement	230 ± 20%
Power consumption	7.5 VA max
Permanent overload	280 V phase-neutral
FREQUENCY MEASUREMENT	
Frequency measurement	45-65 Hz
ENERGY MEASUREMENT	
Active	Yes
Reactive	Yes
Total and partial reading	Yes
MID metering	Bidirectional with single-phase
Resolution	10 Wh, 10 varh
ENERGY ACCURACY	
Active energy Ea+	Class B (EN 50470-3) E02 Class 1 (EN 62053-21)
Reactive energy Er+	Class 2 (EN 62053-23)
METROLOGICAL LED (Ea+)	
Pulse value	5000 pulses / kWh
Colour	Red

PULSE OUTPUT	
Type	Opto-isolated - 5 ... 27 VDC 27 mA according to EN 62053-31
Pulse weight	100 Wh
DISPLAY	
Type	7-digit LCD with backlight
Refresh time	0.5 s
Backlight activation time	10 s
Active energy: 1 display, 7-digit	000000.0 - 999999.9 kWh
Reactive energy: 1 display, 7-digit	000000.0 - 999999.9 kvarh
Realtime active power: 1 display, 4-digit	00.00 - 99.99 kW
Realtime reactive power: 1 display, 4-digit	00.00 - 99.99 kvar
Realtime voltage: 1 display, 4-digit	000.0 ... 999.9 V
Realtime current: 1 display, 4-digit	00.00 ... 99.99 A
Power factor: 1 display, 4-digit	0.001-1.000
Frequency: 1 display, 4-digit	45.00-65.00 Hz
SAVING	
Energy registers	In the EEPROM memory
ENVIRONMENTAL CONDITIONS	
Mechanical environment	M1
Electromagnetic environment	E2
Operating temperature range	-25°C to +55°C
Storage temperature	-25°C to 75°C
Humidity	≤ 80%
Installation	Internal (box/cabinet)
Vibrations	±0.075 mm
HOUSING	
Dimensions W x H x D (mm)	Modular - width of 1 module (DIN 43880) 18 x 90 x 70
Installation	On DIN rail (EN 60715)
Connection capacity, tightening torque	See chapter "6. Connection", page 10
Protection index	Front: IP51 - casing: IP20
Insulation class	Class II (EN 50470-1)
Weight	100 g

13. GLOSSARY OF ABBREVIATIONS

GB	Metrological firmware version
CS	Checksum of metrological firmware
Set-up?	Set-up menu
RESALL	Reset all partial energies
SAVE?	Confirm selection
Y	Save and exit
N	Exit without saving
C	Continue without saving

CORPORATE HQ CONTACT:
SOCOMECSAS
1-4 RUE DE WESTHOUSE
67235 BENFELD, FRANCE

www.socomec.com

