

# ATyS C55/65

ATS Controller



1. GENERAL SAFETY INSTRUCTIONS .....	6
2. INTRODUCTION .....	7
3. QUICK START .....	8
4. GENERAL OVERVIEW .....	12
5. ENVIRONMENTAL .....	13
5.1. IP Rating .....	13
5.2. IK Rating .....	13
5.3. Operating Conditions .....	13
5.3.1. Temperature .....	13
5.3.2. Hygrometry .....	13
5.3.3. Altitude .....	13
5.4. Storage Conditions .....	13
5.4.1. Temperature .....	13
5.4.2. Hygrometry .....	13
5.4.3. Storage duration period .....	14
5.4.4. Storage position .....	14
5.4.5. Volume and shipping weights by reference ATyS .....	14
6. STANDARD COMPLIANCE AND MARKING .....	15
7. CONTENT OF PACKAGING .....	15
8. INSTALLATION .....	16
8.1. Product dimensions (in/mm) .....	16
8.2. Mounting .....	16
8.2.1. Door mounting .....	16
8.2.2. Backplate mounting .....	17
9. CONNECTION .....	20
9.1. Connectors .....	20
9.2. Power Supply .....	22
9.3. AC Dual Power Supply / Sensing .....	22
9.4. DC Power Supply .....	22
9.5. Energy Backup .....	23
9.6. Current Measurement .....	23
9.6.1. Command circuits .....	25
10. FIRST POWER UP – SMART WIZARD .....	27
11. VISUALISATION OPTIONS .....	30
11.1. The visualisation DASHBOARDS .....	30
11.2. Mimic .....	31
11.3. Status .....	31
11.4. Metering .....	32
11.5. P&E .....	32
11.6. Timers .....	33
11.7. Alarms .....	33
11.8. I/O .....	33
11.9. Maintenance .....	34
11.10. The visualisation POP-UPS .....	34



<b>12. OPERATION AND CONTROL</b> .....	<b>35</b>
12.1. HMI use .....	35
12.2. Navigation Menu .....	36
12.3. Operating modes .....	36
12.4. Availability conditions .....	37
12.5. Test operating mode .....	39
<b>13. MAIN MENUS DETAILS</b> .....	<b>40</b>
13.1. Control Menu .....	40
13.2. Log/event history .....	41
13.3. Statistics menu .....	42
13.4. Genset scheduler / Engine Exerciser Menu .....	43
13.5. About .....	45
13.6. Other main menus .....	45
<b>14. CONFIGURATION</b> .....	<b>46</b>
14.1. Configuration through the display .....	46
14.1.1. NETWORK parameters menu .....	47
14.1.2. LOAD parameters menu (only C65) .....	53
14.1.3. DISPLAY parameters menu .....	54
14.1.3.1. SCREEN PARAMETERS .....	54
14.1.3.2. DATE AND TIME .....	54
14.1.3.3. LED CONFIG .....	55
14.1.4. TIMERS parameters menu .....	56
14.1.4.1. Operation timers .....	56
14.1.4.2. Genset source 1/2 timers .....	56
14.1.4.3. Test on/off load timers .....	57
14.1.5. I/O parameters menu .....	58
14.1.6. COMMUNICATION parameters menu .....	59
14.1.6.1. RS485 .....	59
14.1.6.2. Communications Menu .....	60
14.1.6.3. Digiware .....	61
14.1.6.4. Ethernet .....	61
14.1.6.5. I/O module connections .....	62
14.1.7. ALARMS parameters menu .....	63
14.1.8. PASSWORDS .....	67
14.2. Specific Functions Menu .....	68
14.2.1. Manual retransfer .....	68
14.2.2. In-phase transfer (C65 only) .....	68
14.2.3. Return to 0 .....	69
14.2.4. Load control (C65 only) .....	69
14.2.5. Load shedding (C65 only) .....	70
14.2.6. Power up in auto .....	70
14.2.7. DBT Timer in CTRL (C65 only) .....	70
14.2.8. HVAC compressor (C65 only) .....	70
14.2.9. Tripping actions .....	71
14.2.10. LOAD ADDING DELAY .....	72
14.2.11. CYCLER .....	73
14.2.12. COMMIT .....	74
14.3. Maintenance Menu .....	74
14.4. Configuration through EasyConfig System software .....	76

15. MAINTENANCE . . . . .	77
15.1. About the controller . . . . .	77
15.2. Faults management and Troubleshooting . . . . .	78
15.3. Maintenance of the controller . . . . .	79
15.4. Spare parts . . . . .	80
15.5. Accessories and expansion modules . . . . .	81
16. ANNEXES . . . . .	82
Annex 16 - 1. Wiring Diagrams . . . . .	82
16.1.1. Connection diagram with ATYS d . . . . .	82
16.1.2. Connection diagram with Circuit Breakers . . . . .	83
16.1.2.1. With mechanical interlock . . . . .	83
16.1.2.2. With electrical interlock . . . . .	84
16.1.3. Connection diagram with ATyS dH . . . . .	85
16.1.4. Connection diagram with ATyS dM . . . . .	87
Annex 16 - 2. Timers list . . . . .	88
Annex 16 - 3. Input list . . . . .	91
Annex 16 - 4. Output list . . . . .	94
Annex 16 - 5. Operating sequences . . . . .	96
Annex 16 - 6. ATyS C55/C65 Technical characteristics . . . . .	98
Annex 16 - 7. Full menu architecture . . . . .	101
Annex 16 - 8. Communications table . . . . .	109



# 1. GENERAL SAFETY INSTRUCTIONS

- This manual provides instructions on safety, connections instructions on the SOCOMEC ATyS C55 / C65 ATS controller.
- Whether the ATyS C55 / C65 is sold as a loose product, as a spare, in a kit or as part of an enclosed solution or in any other configuration, this device must always be installed and commissioned by qualified and experienced personnel, in line with the manufacturers recommendations, following good engineering practices and after having read and understood the details in the latest release of the relative product instruction manual.
- Maintenance on the product and any other associated equipment including but not limited to servicing operations must be performed by adequately trained and qualified personnel.
- Each product is shipped with a label or other form of marking including rating and other important specific product information. One must also refer to and respect markings on the product prior to installation and commissioning for values and limits specific to that product.
- Using the product outside the intended scope, outside SOCOMEC recommendations or outside the specified the specified ratings and limits can cause personal injury and/or damage to equipment.
- This instruction manual must be made accessible so as to be easily available to anyone who may need to read it in relation to the use, installation or maintenance of the ATyS C55/C65
- The ATyS C55/C65 meets the requirement for the IEC 60947-6-1 standard for transfer switching equipment and the IEC 61010-2-201 standard for control equipment; the product includes the labels and marking with details on each standard.
- No covers on the ATyS C55/C65 should be opened (with or without voltage) as there may still be dangerous voltages inside the product such as those from external circuits.
- **Do not handle any control or power cables connected to the ATyS C55/C65 when voltages may be present on the product directly through the mains or indirectly through external circuits.**
- Voltages associated with this product may cause injury, electric shock, burns or death. Prior to carrying out any maintenance or other actions on live parts in the vicinity of exposed live parts, ensure that the switch including all control and associated circuits are de-energized.

 <b>DANGER</b>	 <b>WARNING</b>	 <b>CAUTION</b>
<b>RISK:</b> Electric shock, burns, death	<b>RISK:</b> Possible personal injury	<b>RISK:</b> Equipment damage

- The ATyS C55/C65 complies with the following international standards:
  - IEC 60947-6-1 – Transfer switching equipment
  - EC 61010-2-201 – Control equipment
  - IEC 61010-1 – Electrical safety requirements
  - Annex C of GB/T 14048.11

Refer to the specific references numbers on this document to order the correct products and associated accessories. The information provided in this instruction manual is subject to change without notice, remains for general information only and is non-contractual.

## 2. INTRODUCTION

ATYS C55 and C65 ATS controllers are compliant to international product standards and are designed specifically for use in low voltage power applications to ensure the safe transfer of a load supply between a normal and an alternate source.

Besides product standards the C55 and C65 are designed to meet IEC 60364 and IEC 61439 installation standard requirements (C55/65) as well as NFPA 110 and NFPA 70 (NEC) when using the specific UL reference (C66).

**This version of instruction sheet is based on C55 and C65 products with firmware version 2.X**

### **ATyS C55/65 range of automatic transfer switch (ATS) controllers ensure:**

- Safe controls for transfer between a normal and alternate source
- A manufacturer assembled and tested solution
- Intuitive and simple controls for local operation
- Quick easy and safe electrical manual operation
- Straightforward installation with effective ergonomics
- A simple and secure control interface
- Easy mounting and smart configuration
- Suitable for indoor and outdoor applications (IP65) with gasket.

### **Glossary:**

ATS:	Automatic Transfer Switch
ACB:	Air Circuit Breaker
MCCB:	Molded Case Circuit Breaker
FT:	Fast Transfer
DT:	Delayed Transition
SCPD:	Short Circuit Protection Device
CT:	Current Transformer
VT:	Voltage Transformer
GND:	Ground
I/O:	Inputs/Outputs
RTC:	Real Time Clock
ECS:	Easy Config System
S1:	Source 1
S2:	Source 2

# 3. QUICK START



## ATyS C55/65

ATS CONTROLLER

### Preliminary operations

Check the following upon delivery and after removal of the packaging:

- Packaging and contents are in good condition.
- The product reference corresponds to the order.
- Contents should include:
  - Qty 1x C55 or C65 Controller
  - Qty 1x Controller IP65 gasket (C65 only)
  - Qty 4x Door mounting screws
  - Qty 1x Connector kit
  - Qty 4x Backplate mounting feet

### Warning

- ⚠ Risk of electrocution, burns or injury to persons and / or damage to equipment. This Quick Start is intended for personnel trained in the installation and commissioning of this product. For further details refer to the product instruction manual available on the SOCOMEC website.
  - This product must always be installed and commissioned by qualified and approved personnel.
  - Maintenance and servicing operations should be performed by trained and authorized personnel.
  - Do not handle any control or power cables connected to the product when voltage may be, or may become present on the product, directly through the mains or indirectly through external circuits.
  - Always use an appropriate voltage detection device to confirm the absence of voltage.
  - Ensure that no metal objects are allowed to fall in the cabinet (risk of electrical arcing).
- Failure to observe good engineering practices as well as to follow these safety instructions may expose the user and others to serious injury or death.

- ⚠ Risk of damaging the device  
In case the product is dropped or damaged in any way it is recommended to replace the complete product.  
Installation standards must be respected.

### Accessories

- Digeware I/O 10 (ref. 48290140)
- Gateway M70 (ref. 48290222)
- Controller 24 VDC aux power supply (6W minimum type SELV) mandatory with I/O 10 Modules

For further details refer to the product instruction manual under chapter "Spares and Accessories"

### Spares

- Connector kit (ref. 16090002)
- Controller backplate mounting feet (ref. 16090005)
- Controller door mounting screws (ref. 16090004)
- Controller IP65 gasket (ref. 16090001) (C55/65)

CORPORATE HQ CONTACT:  
SOCOMECSAS,  
1-4 RUE DE WESTHOUSE,  
67235 BENFELD, FRANCE

[www.socomec.com](http://www.socomec.com)  
To download, brochures,  
catalogues and technical manuals

**IEC 61010**  
Non contractual document.  
Subject to change without notice.

### Installation and Commissioning

<b>STEP 1</b>	<b>STEP 2</b>	<b>STEP 3</b>	<b>STEP 4</b>	<b>STEP 5</b>
Installation	Connections	Configuration	Visualization	Menus & programming



### Connection diagram with ATYS d

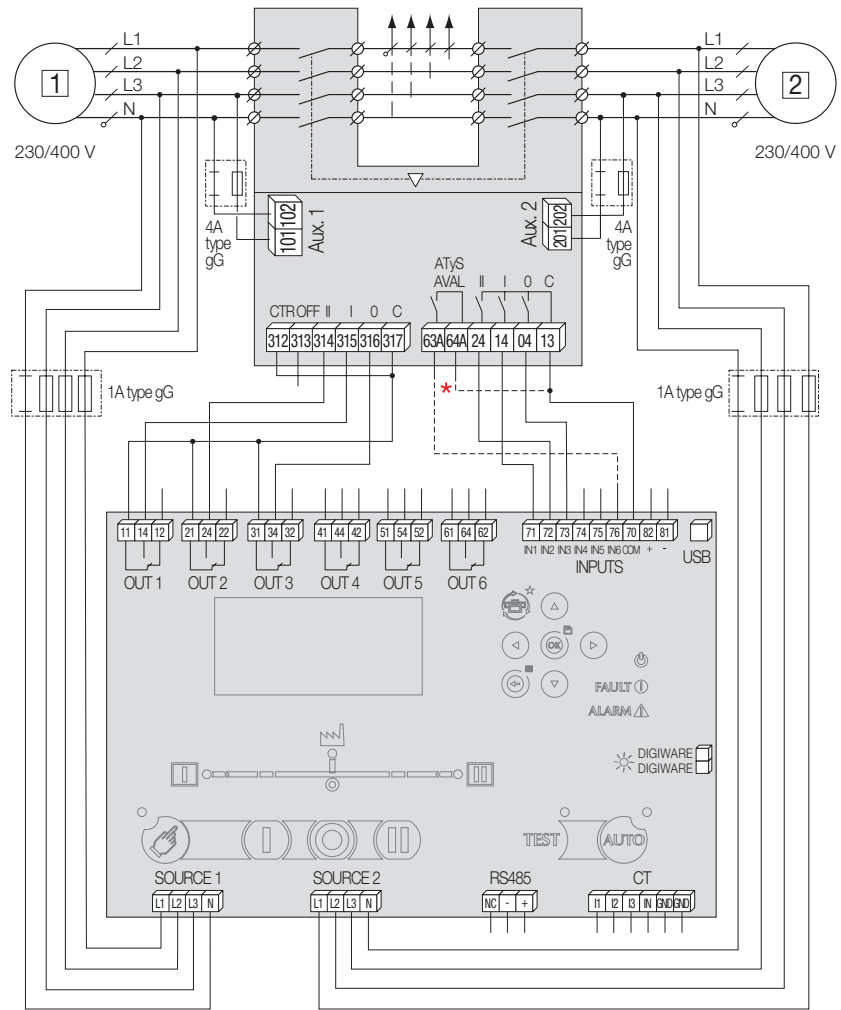

\* The use of this input is optional, when used configure IN6 to «DOOR OPEN» in mode «NC».



## Product dimensions

Dual Dimensions  
in/mm

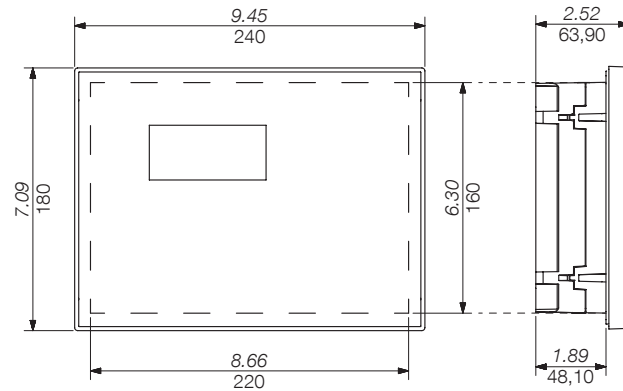

## 1 Mounting & connecting controller

### Door mounting

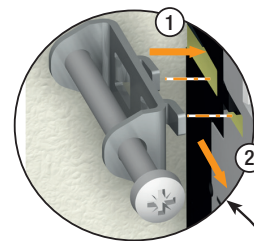
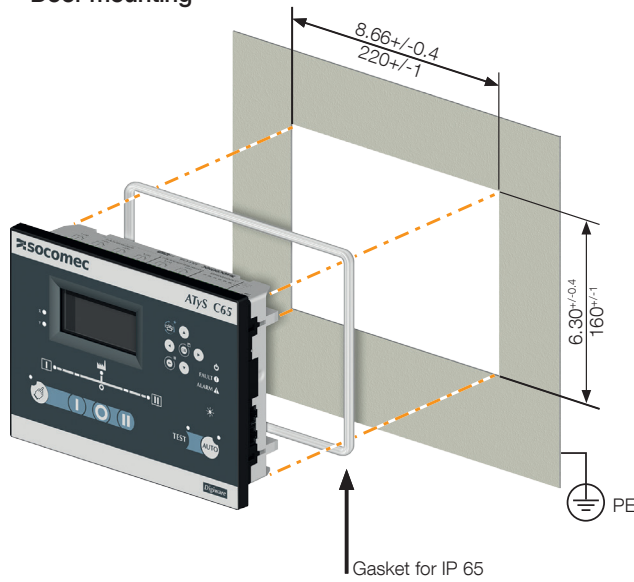

Insert the 4 door mounting screws in the designated slot and push back to lock in place.

Example of cable way.

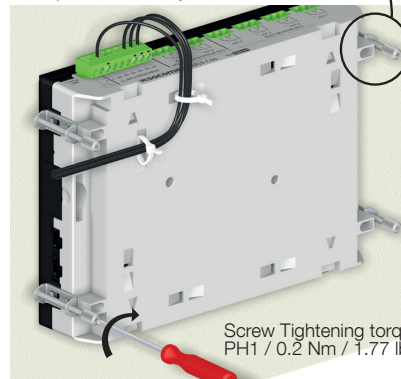

Screw Tightening torque  
PH1 / 0.2 Nm / 1.77 lb.in

### Backplate mounting

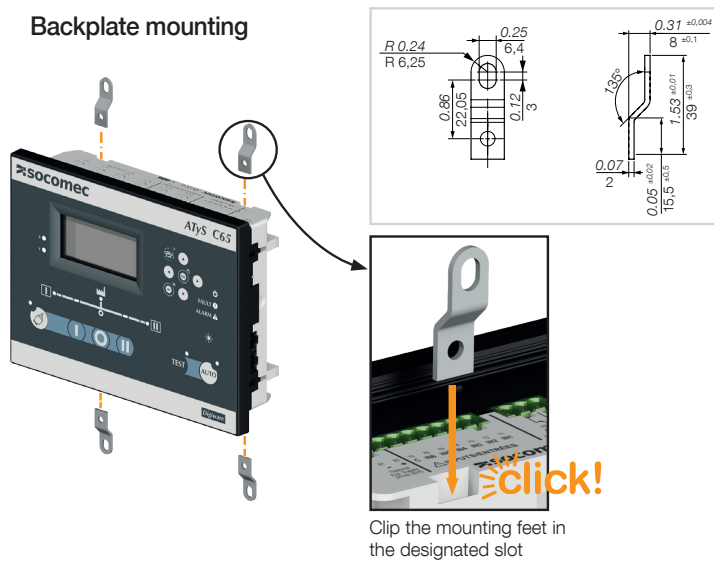

Clip the mounting feet in the designated slot

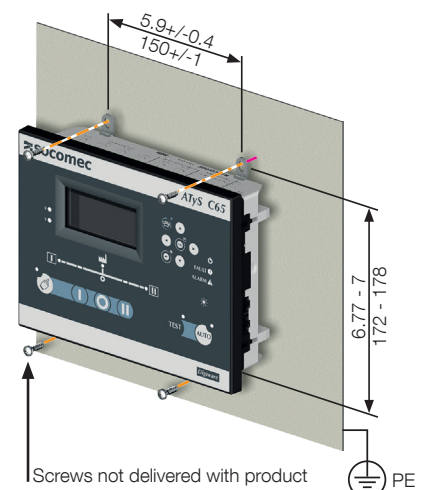

Screws not delivered with product

## 2 Controller wiring

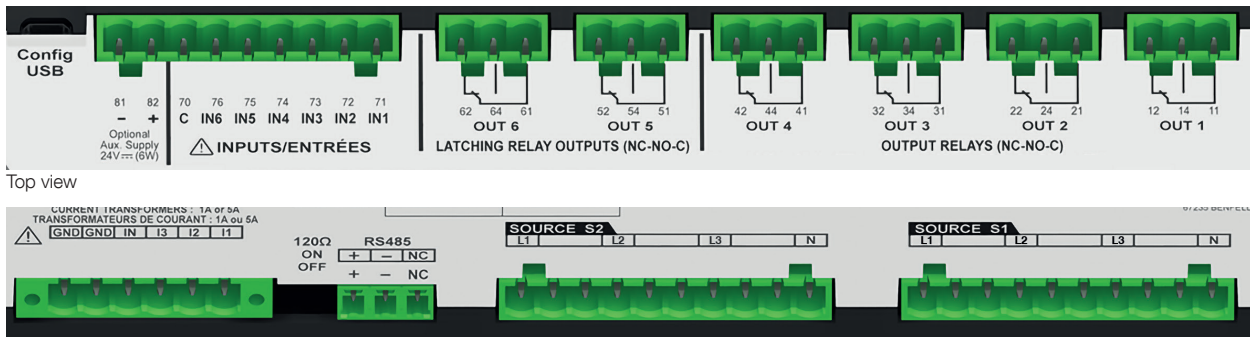

Bottom view

TYPE	TERMINAL N°	DESCRIPTION	CHARACTERISTICS	RECOMENDED CROSS SECTION	TIGHTENING TORQUE
Sensing source 1	SOURCE 1 L1/L2/L3/N	Voltage sensing inputs source 1 & voltage supply (L1-L2)	Sensing voltage 50 - 575 V.a.c P-P - 50/60 Hz (+/- 10%) Supply voltage (L1-L2)	0.75-2.5mm <sup>2</sup> AWG 18-14	0.5-0.6 Nm 4.4-5.3 lb.in
Sensing source 2	SOURCE 2 L1/L2/L3/N	Voltage sensing inputs source 2 & voltage supply (L1-L2)	88 - 576 V.a.c - 50/60Hz (+/- 10%) Ui 600V		
Inputs	71	IN1: programmable input 1	Do not connect to any external power supply	0.5-2.5mm <sup>2</sup> AWG 20-14	
	72	IN2: programmable input 2			
	73	IN3: programmable input 3			
	74	IN4: programmable input 4			
	75	IN5: programmable input 5			
	76	IN6: programmable input 6			
Aux power supply	81/82	- : negative terminal for aux supply + : positive terminal of aux supply	12-24 Vd.c.		
Outputs	12/14/11	OUT1: programmable output 1	Dry contacts 8A / 277 VAC 50/60 Hz 5A / 24 VDC	1.5-2.5mm <sup>2</sup> AWG 16-14	
	22/24/21	OUT2: programmable output 2			
	32/34/31	OUT3: programmable output 3			
	42/44/41	OUT4: programmable output 4			
	52/54/51	OUT5: programmable output 5 (latching)			
	62/64/61	OUT6: programmable output 6 (latching)			
Current transformers	IN/3/2/1	CT neutral / CT phase C / CT phase B / CT phase A	CT input 1A or 5A		
Serial connection	RS485	Connection RS485 - : negative terminal of RS485 bus + : positive terminal of RS485 bus NC : Ground	RS485 bus insulated	LIYCY shielded twisted pair 0.14 to 1.5 mm <sup>2</sup> 30-14 AWG	0.22 -0.25 Nm
Digiware*	DIGIBUS	Connection point for I/O 10 optional accessories & digiware connection (must use 24 VDC input)	RJ 45 digiware cable	-	-

\* For more information check I/O module instruction sheet ref 545597

## 3 Configuration

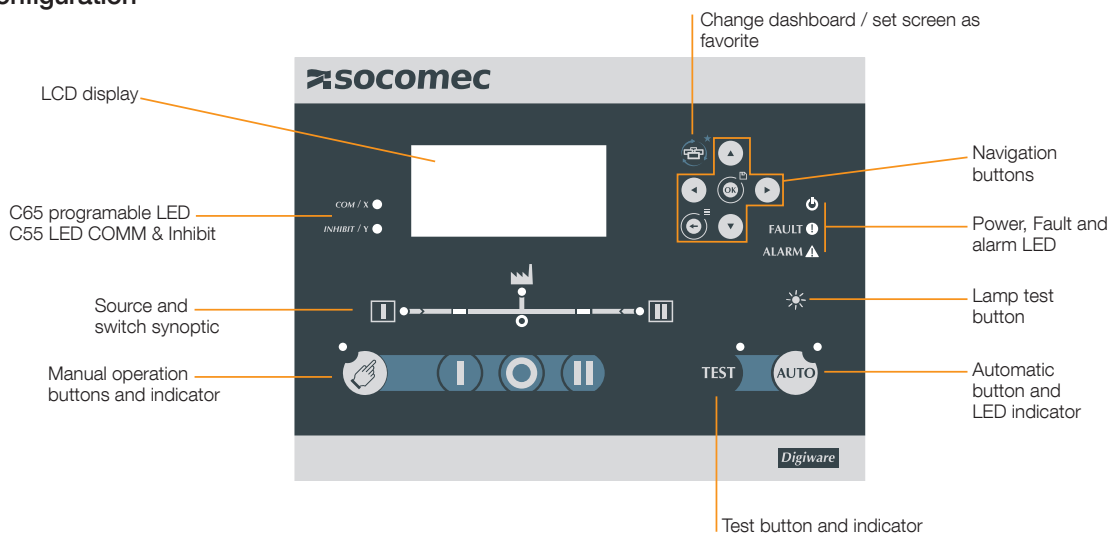

### SMART WIZARD CONFIG:

When powered for the first time the controller will prompt the user to configure using the wizard. To access the wizard input code 1000 then the configuration will go as follow:



For advanced configuration go to parameters menu.

## 4 Visualization

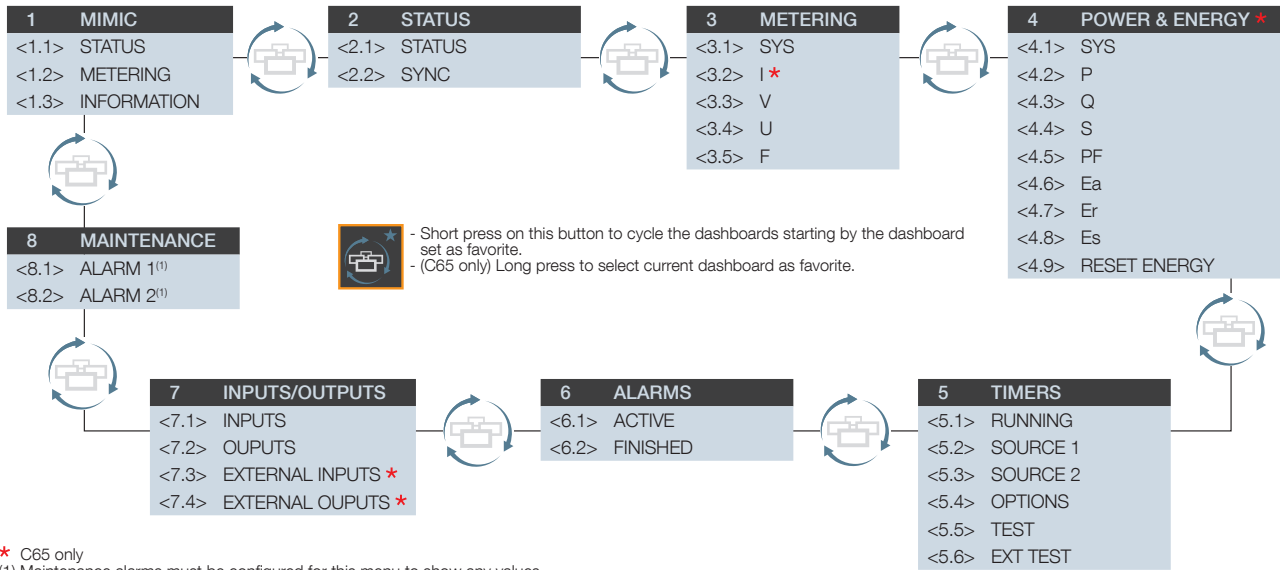

## 5 Menu & programming

- Short press on this button to go back one level.  
 - Long press to access the menus.

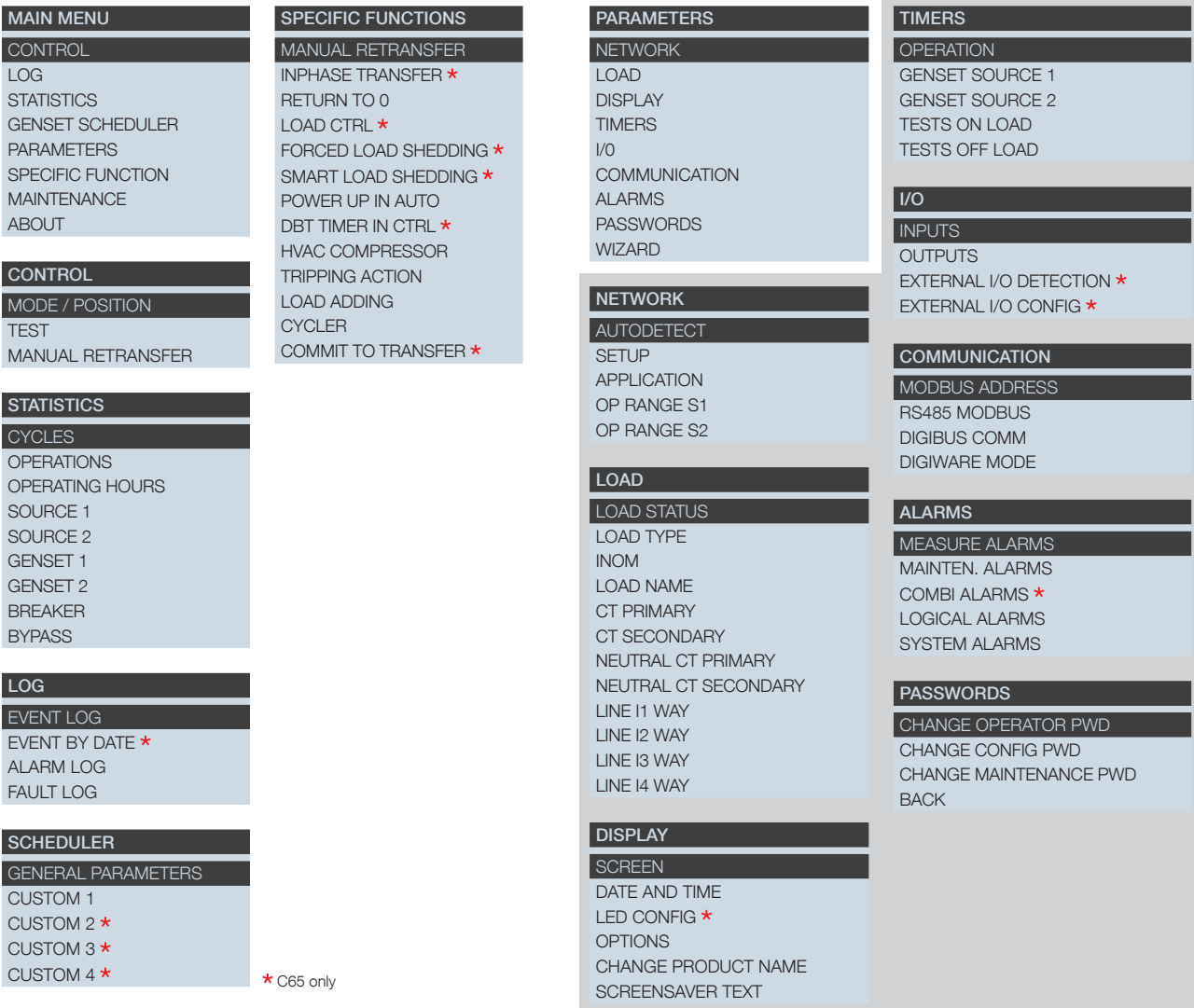

## 4. GENERAL OVERVIEW

The ATyS C55/C65 ATS Controller reference includes:

- 1 ATS Controller
- 1 ATyS C65 IP65 gasket (available as accessory for C55)
- 1 ATyS Cx5 door mounting kit
- 1 ATyS Cx5 backplate mounting kit
- Quickstarts instruction sheet

All other components described in this instruction manual are available as accessories and sold separately.

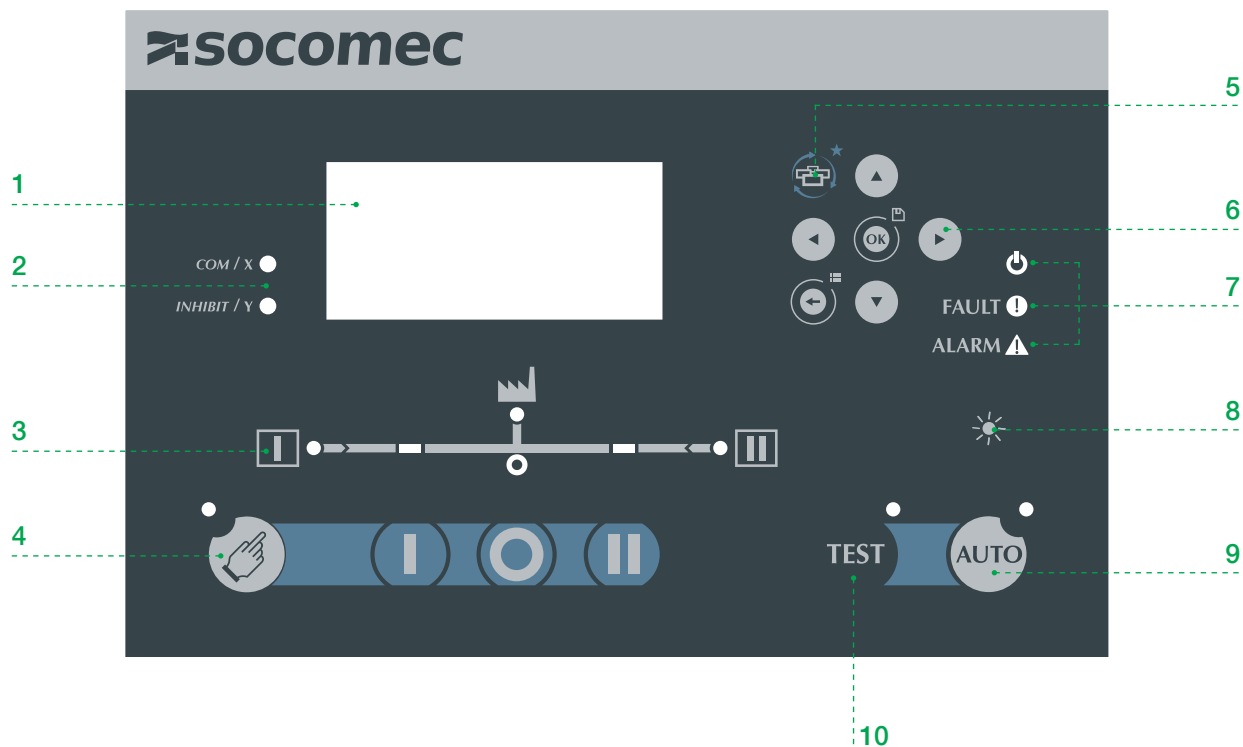

1. LCD display
2. C65 programmable LED's / C55 Fixed LED's for COMM & Inhibit
3. Source availability and switch position synoptic
4. Electric manual operation push buttons and status indicator
5. Change dashboard screen / set screen as favorite (hold 1,5s to set screen as favourite)
6. Navigation arrows (Up/Down/Left/Right)
7. Power, Fault and alarm LED
8. Lamp test button / Clear faults (hold 1,5s to clear faults)
9. Automatic mode push button and LED status indicator
10. Test button and status indicator

## 5. ENVIRONMENTAL

The ATyS C55/65 controllers meet the following environmental requirements:

### 5.1. IP Rating



- IP65 door mounted with gasket.
- IP30 door mounted without gasket.
- IP2X on the back of the controller.

### 5.2. IK Rating

- IK 8 (6.8 J) rating according to IEC 61010-2-201

### 5.3. Operating Conditions

#### 5.3.1. Temperature



- From -30 to +70°C



Note: with limitations on the LCD screen that may show temporary distortion below -10°C.

#### 5.3.2. Hygrometry



- 95% humidity without condensation at 55°C

#### 5.3.3. Altitude



- Up to 2000m

### 5.4. Storage Conditions

#### 5.4.1. Temperature



- From -40 to +70°C

#### 5.4.2. Hygrometry



- Recommendation: to be stored in dry, non-corrosive and non-saline atmospheric conditions.

### 5.4.3. Storage duration period



- Maximum storage up to a period of 12 months

### 5.4.4. Storage position



- Maximum of 5 boxes may be stacked vertically



### 5.4.5. Volume and shipping weights by reference ATyS

Product	Reference Number	Weight (kg)		Volume (mm) inc packing
		Net	Gross	
ATyS C55	1600 0055	1,060	1,500	295x255x115 (LxWxH)
ATyS C65	1600 0065	1,080		

## 6. STANDARD COMPLIANCE AND MARKING

CE marking



Cmim



EAC



Lead free process



WEEE Directive 2012/19/EU



### Standards compliance

Certified according to :

IEC 61010-2-201

IEC 61010-1

GB/T 14048.11 Annex C

Conform to the requirements of :

IEC 60947-6-1 when used with an IEC 60947-6-1 certified RTSE (Remotely operated transfer switch).

NFPA 70\* (Specific UL Reference).

NFPA 110\* (Specific UL Reference).

(\* For a UL certified product, SOCOMEC provide reference 1600 0066 (ATyS C66, that is UL61010 listed and UR 1008 recognised as a standalone ATS controller as well as UL1008 listed in association with ATyS FT or ATyS DT transfer switching equipment)

## 7. CONTENT OF PACKAGING

The ATyS C55/C65 packaging includes:

- Qty 1 x Quickstart guide
- Qty 1 x C55 or C65 Controller
- Qty 1 x Connector kit
- Qty 1 x Controller IP65 gasket (C65 only)
- Qty 4 x Door mounting screws
- Qty 4 x Backplate mounting feet

# 8. INSTALLATION

## 8.1. Product dimensions (in/mm)

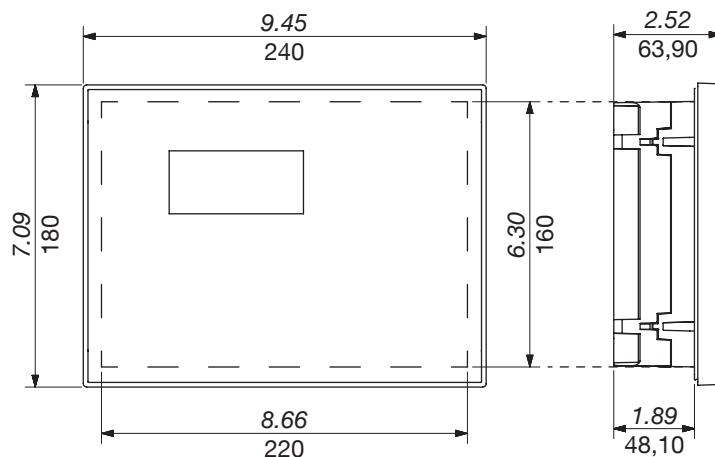

## 8.2. Mounting

The ATyS C55/65 can be mounted either on the door or on the backplate of an enclosure (both mounting kits are delivered with the product).

### 8.2.1. Door mounting

The ATyS C55/C65 can be mounted on doors up to with a thickness 4mm (0.15in).

#### STEP 1: Cut out for the controller

Cut a rectangle hole of 220x160mm / 8.66 x 6.3in on the enclosure door as shown below.

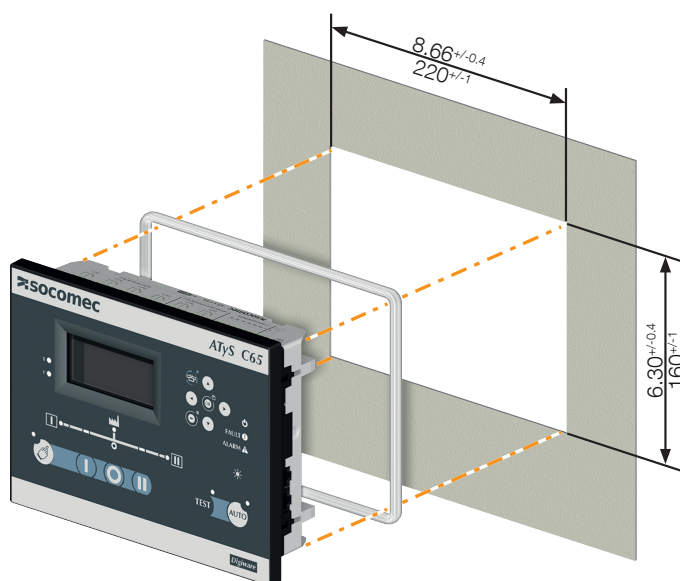

**CAUTION !** For IP65 protection, the gasket must be placed and fitted around the inside edge of the controller as shown above.



## STEP 2: Fixing the controller on the door:

Remove all connectors then place the ATS controller inside the door cut-out and clip the door mounting screws into the side of the controller (2 screws on each side). It is important to respect the tightening torque indicated below and follow good engineering practise when installing the ATS controller.

The back of the controller includes fixing points for cable collars (see illustration below)

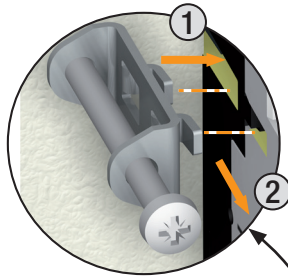

Insert the 4 door mounting screws in the designated slot and push back to lock in place.

Example of cable way.

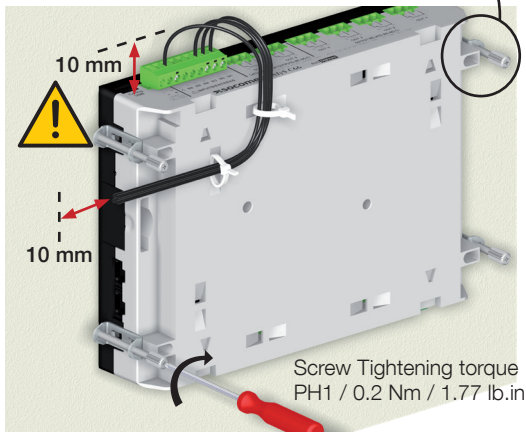

Cable must be more than 10mm away from the RTC battery cover and USB.



Do not drill holes above the controller after it has been mounted.

## 8.2.2. Backplate mounting

### STEP 1: Placing the 4 mounting legs on the controller

Insert the mounting legs into the 4 slots (2 top side and 2 bottom side, (cf. below top side view).

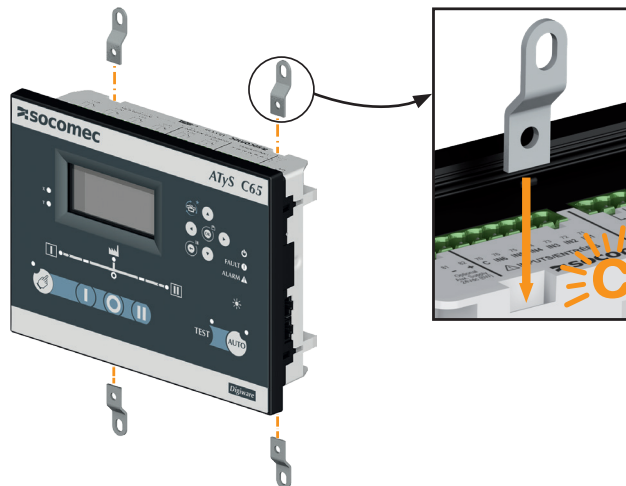
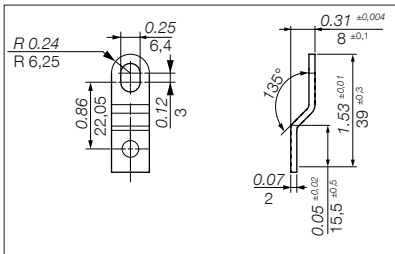

## STEP 2: Fixing the controller on the backplate

Drill mounting holes in the backplate to match the fixing holes as shown and indicated below. Fix the controller through the mounting legs to the backplate with a maximum screw diameter of 6mm/0.22in.

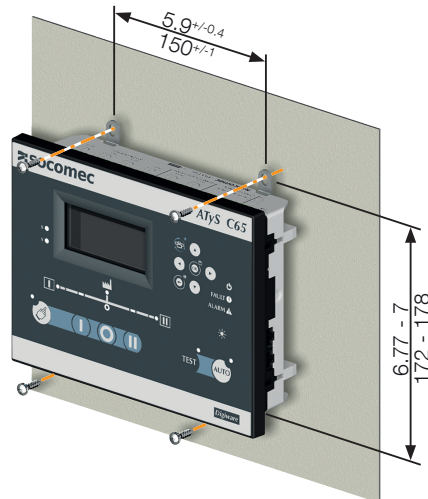

## Mounting of Digital I/O extension modules (Accessory for C65 only):

Digital I/O modules are accessories not delivered with the product. These optional modules can be ordered using the references below:

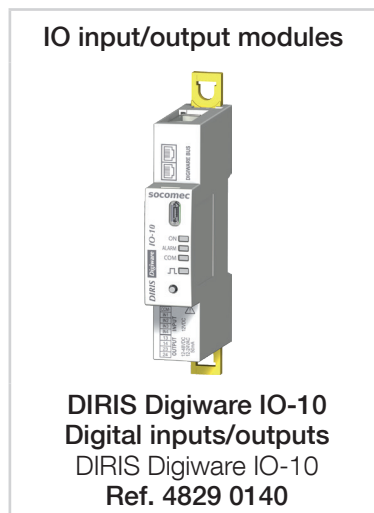

Digital I/O modules provide additional inputs /outputs to be used with/by the ATyS C65. The maximum length of the digiware bus is 100 meters.



**CAUTION !** The maximum number of I/O optional modules that can be added through the Digiware bus to the controller is 6; this is equivalent to 24 digital inputs and 12 digital outputs. In order to use the I/O modules the 24VDC input of the C65 controller must be supplied with 24 VDC.

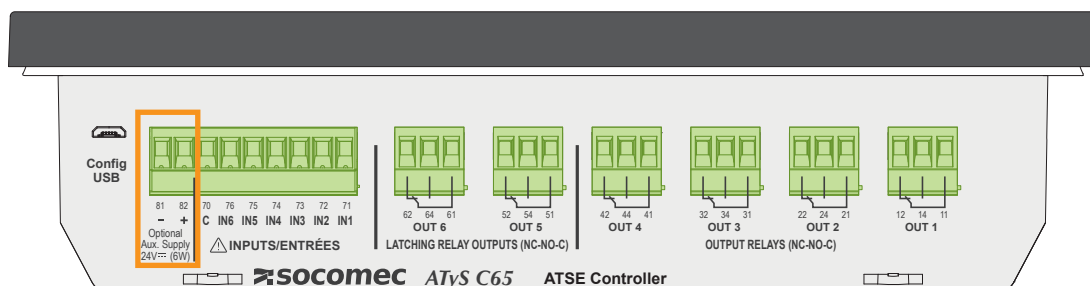

An end-of-the-bus resistor is necessary for a correct communication between the modules and the controller:

	QUANTITY	PART NUMBER
	1	4829 0180

### Mounting the I/O modules:

Position the I/O modules on DIN rail or on backplate as shown on the image below.

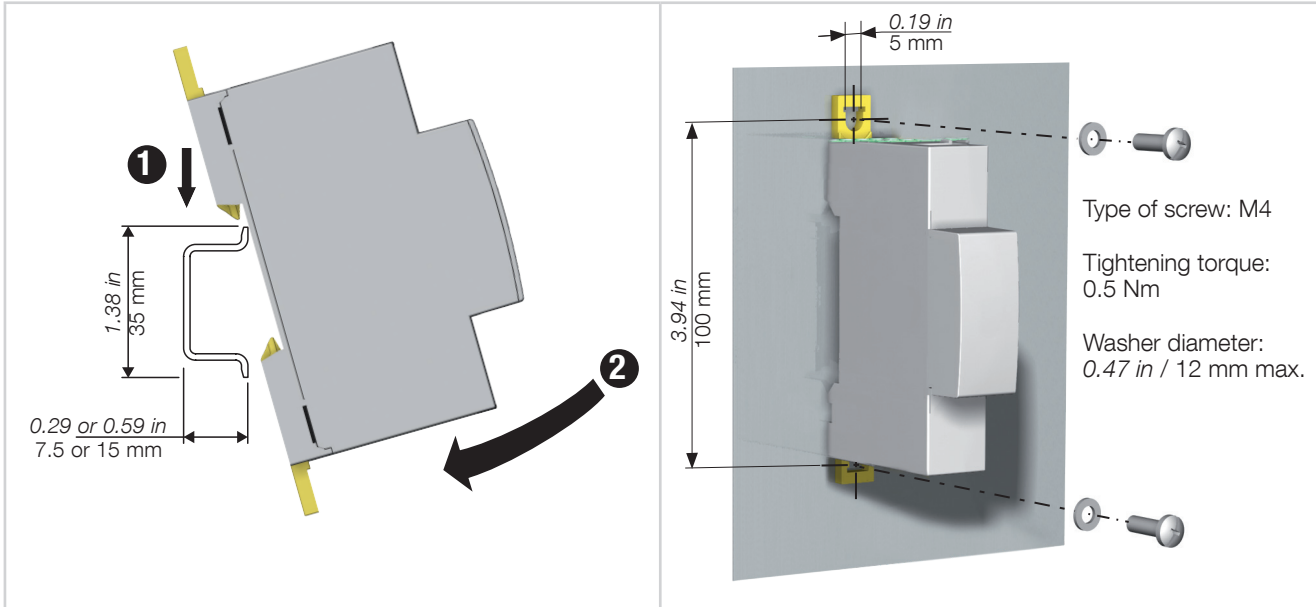

The connection between modules and to the ATyS C65 Digiware input is on the side of the controller by means of an RJ45 connector and after this the other modules are daisy chained (up to 6 modules).

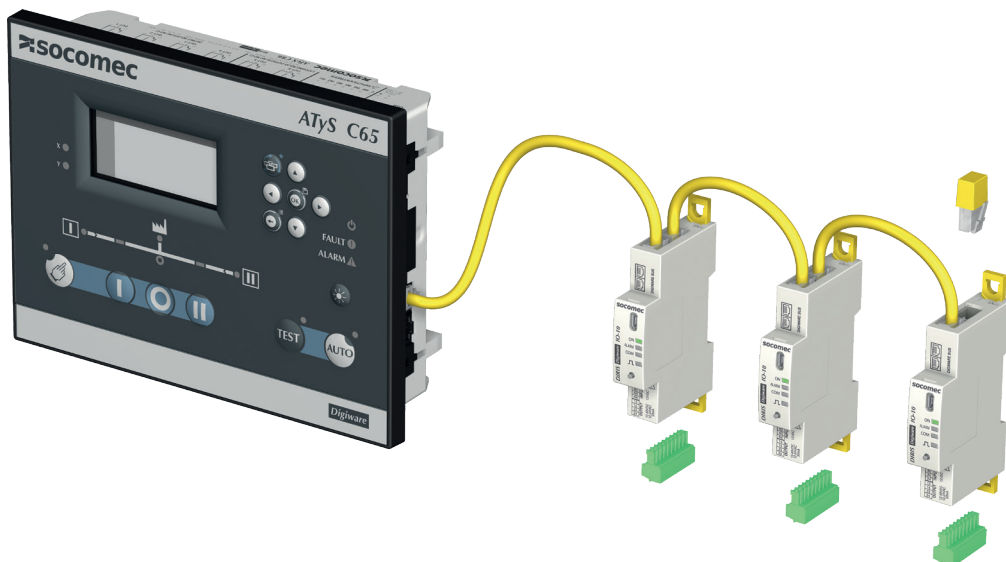

After connecting your I/O modules see chapter "14.1.6.5. I/O module connections", page 62 for details on how to detect and program the I/O modules.

The configuration and the state (function and active or off) of the additional I/O can be visualized at any time by going to Dashboard 7 "I/O" and selecting submenus 7.3 "EXTERNAL INPUTS" and 7.4 "EXTERNAL OUTPUTS"

# 9. CONNECTION

## 9.1. Connectors

Top view:

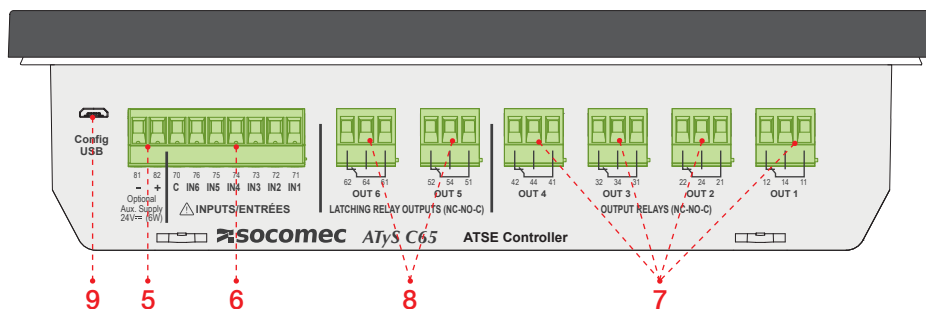

Right side view:

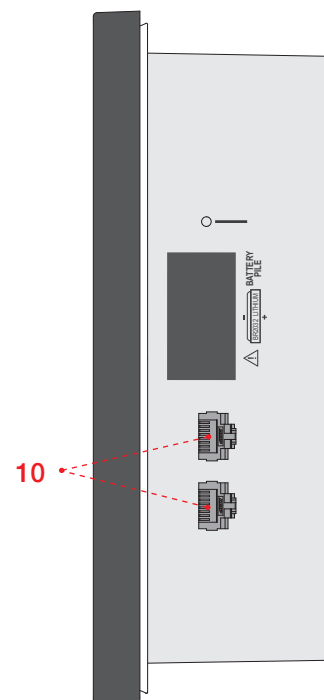

Bottom view:

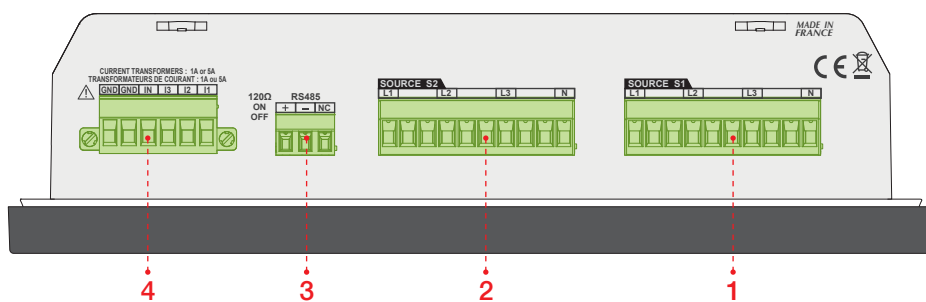

To help secure the control cables during the wiring, the controller includes seven fixing supports on the back of the controller to retain the cables in place using cable ties.

Example of cable way.

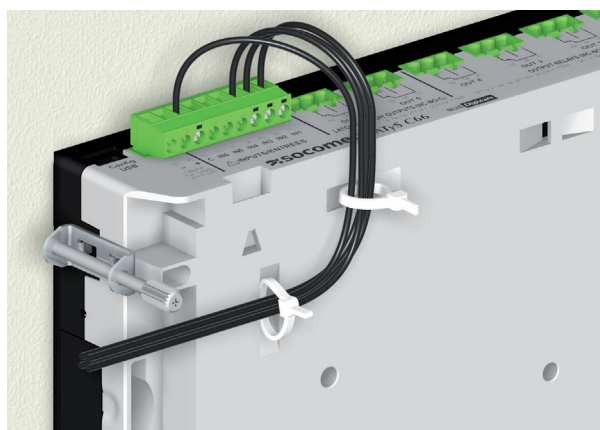

N°	DENOMINATION	TERMINAL	DESCRIPTION	CHARACTERISTICS	RECOMMENDED CABLE SECTION	TIGHTENING TORQUE
1	VOLTAGE SENSING SOURCE 1	L1 / A	Phase 1 / A	1Ph / 3Ph 50 - 332 / 575VAC (50/60 Hz) (+/- 10%) Impulse V. Withstand Test: 6/8kV* Ui 600V	0.75 - 2.5 mm <sup>2</sup> AWG 18-14	0.5-0.6 N.m 4.4-5.3 lb.in
		L2 / B	Phase 2 / B			
		L3 / C	Phase 3 / C			
		N	Neutral			
2	VOLTAGE SENSING SOURCE 2	L1 / A	Phase 1 / A	1Ph / 3Ph 50 - 332 / 575V 575VAC (50/60 Hz) (+/- 10%) Impulse V. Withstand Test: 6/8kV* Ui: 600V	0.75 - 2.5 mm <sup>2</sup> AWG 18-14	0.5-0.6 N.m 4.4-5.3 lb.in
		L2 / B	Phase 2 / B			
		L3 / C	Phase 3 / C			
		N	Neutral			
3	RS 485	+	DATA + (A)	-	LiYCY sheilded twisted pair 0.14 to 1,5 mm <sup>2</sup> / AWG 30 - 14	0.22-0.25 N.m 4.4-5.3 lb.in
		-	DATA - (B)			
		NC	Ground			
4	CURRENT TRANSFORMERS	I1 /Ia	CT phase 1 / A	CT Input /1A or /5A	1.5-2.5 mm <sup>2</sup> AWG 16-14	
		I2 /Ib	CT phase 2 / B			
		I3 /Ic	CT phase 3 / C			
		In	CT neutral			
		GND	Ground			
		GND	Ground			
5	OPTIONAL AUX. SUPPLY 24VDC	81	-	9-28VDC 24VDC -20%/+20% for I/O modules		
		82	+			
6	PROGRAMMABLE INPUTS	70	COMMON	Do no connect to any power supply.  To be used with dry contacts  Line maximum length 100m	0.5-2.5 mm <sup>2</sup> AWG 20-14	0.5-0.6 N.m 4.4-5.3 lb.in
		71	Input 1			
		72	Input 2			
		73	Input 3			
		74	Input 4			
		75	Input 5			
		76	Input 6			
7	PROGRAMMABLE OUTPUTS	11-12 NC/ 11-14 NO	Output 1	Dry contacts 8A / 277 VAC 50/60 Hz 5A / 24 VDC	1.5-2.5 mm <sup>2</sup> AWG 16-14	
		21-22 NC/ 21-24 NO	Output 2			
		31-32 NC/ 31-34 NO	Output 3			
		41-42 NC/ 41-44 NO	Output 4			
8	LATCHING RELAYS	51-52 NC/ 51-54 NO	Output 5			
		61-62 NC/ 61-64 NO	Output 6			
9	CONFIG USB	MicroUSB	USB 2.0 for configuration	-	MicroUSB Type B	-
10	DIGIWARE BUS	BUS	2x RJ45 DIGIWARE BUS	CAT V - 600V RJ45 UTP	RJ45 DIGIWARE CABLE	-



Note:

- Use 7mm as stripping length for the controller terminals.
- Use 90°C copper wire for installations with ambient temperature from 35-60°C. When the ambient temperature is above 60°C, Use 105°C copper wire.
- \* Impulse voltage withstand tests at 6kV between phases of the same source and 8kV between phases of a different source.

## 9.2. Power Supply

The ATyS C55/65 controller is Self-powered from the voltage sensing of any available source, and may also be powered (as a backup) from the DC auxiliary power input (24VDC). Additionally the C65 controller also includes an internal energy backup of 15 seconds (default value, adjustable up to 30s) to keep the controller and communication in operation during a power outage and during the Genset startup.

## 9.3. AC Dual Power Supply / Sensing

The ATyS C55/65 controller will be automatically supplied from the voltage sensing connectors of both sources thanks to an internal DPS (dual power supply) that in case main source failure, will immediately switch to the secondary source supply the device.

**i** Note: the nominal auxiliary power supply feeding the sensing terminals must be within the limits of 88 -> 576 VAC.

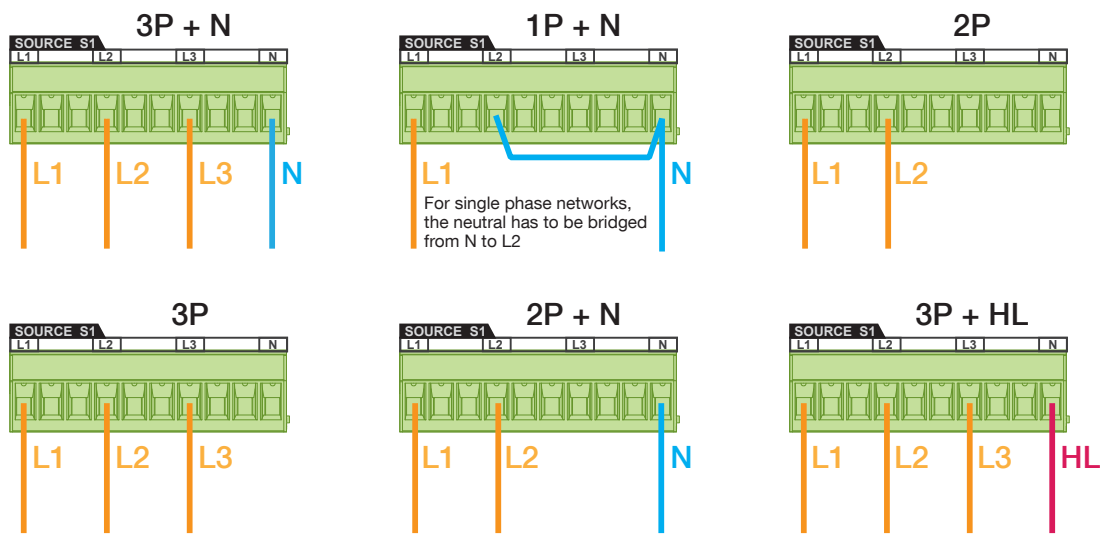

**i** Note: the C55/65 standalone ATS controller must include a SCPD such as fuses on each phase of the voltage sensing control wiring. 1A gG fuses are recommended.

## 9.4. DC Power Supply

The ATyS C55/65 includes an optional DC power supply input to power the controller in case both sources are off for over 15-30 seconds. The DC power supply voltage needed to power up the controller is between 9VDC and 28VDC. The 24VDC power supply is mandatory when using the C65 with additional external I/O modules.

**! WARNING ! DC supply is optional when using the controller alone, but necessary in case of using extension modules (I/O module). When using a DC supply please follow the recommendations below :**

- The 24Vdc is SELV (safety extra low voltage) and must be fused and grounded in the installation.
- The current measurement and the digiware will be at the same potential as the 24Vdc.
- RS485 includes functional insulation

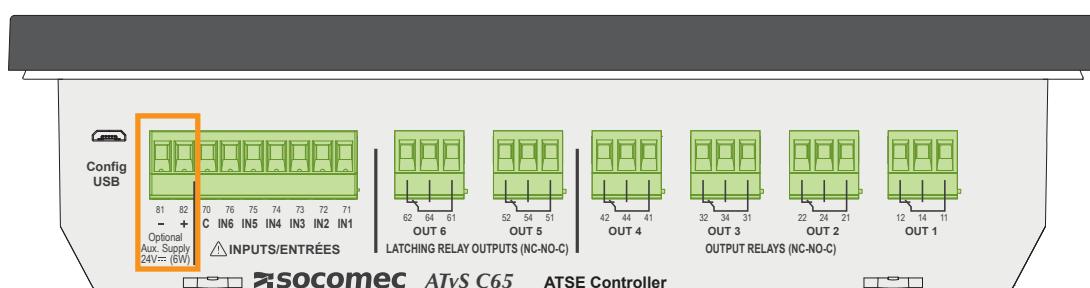

## 9.5. Energy Backup

The ATyS C65 has an internal energy backup that will keep the ATS controller powered for up to 30 seconds. This setting is configured to 15 seconds by default and can be modified inside the maintenance menu "MAIN MENU" > "MAINTENANCE" > "ENERGY BACKUP". The energy backup will activate when both sources are not available and there is no DC power supply included. The backup energy will keep the main functions of the controller powered so as to inform the user about the ATSE status as follows:

- ATS function (sensing, automatism, relays, genset start...)
- Display screen (with backlight)
- Menus navigation and control pushbuttons
- Communications

**i** Note: the Energy backup will supply the ATyS C65 controller excluding accessories such as I/O or other digiware connected devices.

**i** Note: during backup time, inputs will keep their last state in memory, position return information will become blind (position LED info blinking).  
Monostable relays (OUT1 to 4) are still working during the first 15s, then they will be deactivated to minimize power consumption.  
In case the 2 latching relays (OUT5 and OUT6, contacts 51-54 and 61-64) were not driven during energy backup time (controller is now OFF), they will automatically change state after the priority source Fail timer is over to start the generator(s) using their own independent backup power. Even if the controller is off, the application is still able to start the genset with respect of the failure timer of the priority source (maximum delay is 60s, even if failure timer is configured at a higher value)

## 9.6. Current Measurement

Current measurement can be done with current transformers by connecting the secondary of the transformer between the phases I1, I2, I3 and the GND. Neutral can be measured using an additional current transformer. If this is not fitted the neutral current will be calculated using the phase values.

Current transformer's secondary should be /1A or /5A and this configuration needs to be set in "MAIN MENU" > "PARAMETERS" > "LOAD". The accuracy of the current measurement on the controller is +/- 1%.

Recommended cable cross sectional area: 1,5mm<sup>2</sup>.

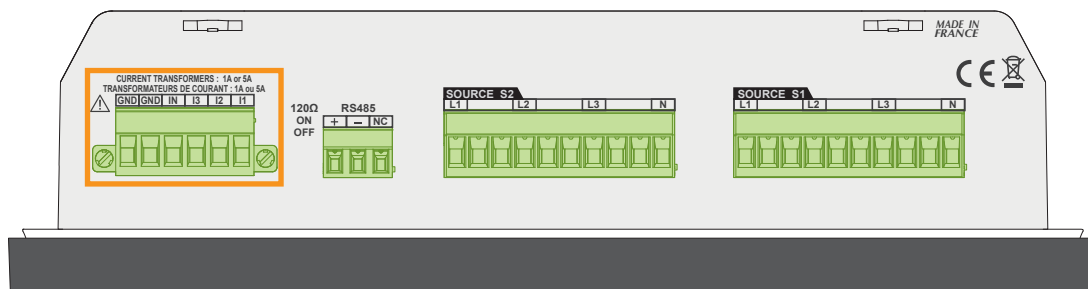

The configuration for the measurement should be done in the Parameters/Load menu (see chapter "14.1.2. LOAD parameters menu (only C65)", page 53).

All secondaries of current transformers should be connected between the correct phase and ground (GND):

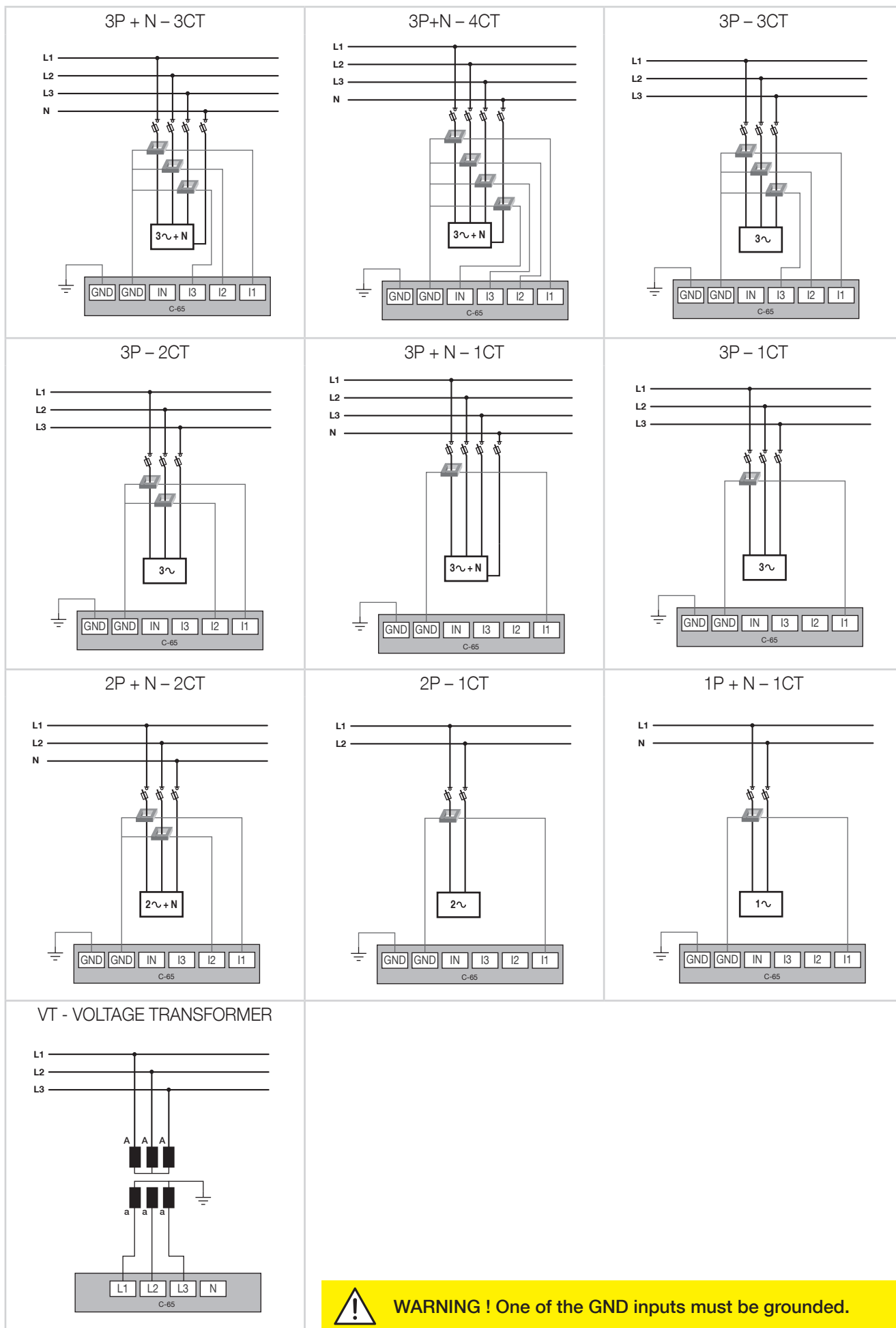

**WARNING ! One of the GND inputs must be grounded.**



## 9.6.1. Command circuits

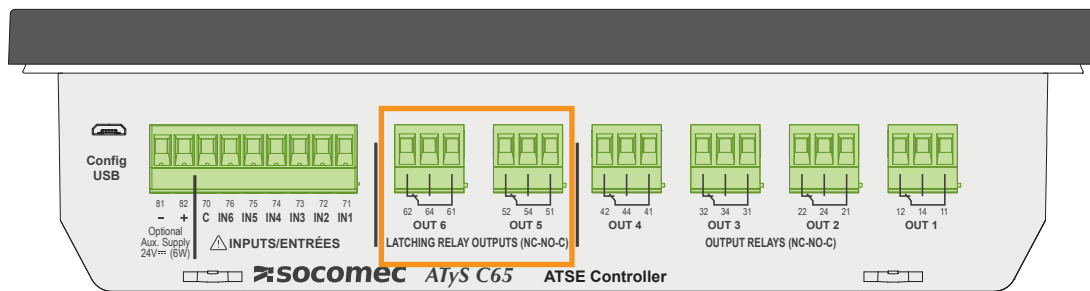

By default, the inputs and outputs in the C55/65 are set up as follows:

		BY DEFAULT	CONFIGURATION CHANGES WHEN CHANGING RTSE TECHNOLOGY			
		ATYS R/D	BREAKERS	CONTACTORS	ATYS FT	ATYS DT
INPUTS	Input 1	SWITCH IN POS 1	BRK1 CLOSED	SWITCH IN POS 1	SWITCH IN POS 1	SWITCH IN POS 1
	Input 2	SWITCH IN POS 2	BRK2 CLOSED	SWITCH IN POS 2	SWITCH IN POS 2	SWITCH IN POS 2
	Input 3	SWITCH IN POS 0	BRK1 OPEN	-	-	SWITCH S1 IN POS 0
	Input 4	INHIBIT	BRK2 OPEN	-	-	SWITCH S2 IN POS 0
	Input 5	MANUAL RETRANS <sup>(1)</sup>	-	-	-	-
	Input 6	DOOR OPEN	-	-	-	-
OUTPUTS	Output 1	POS 1 ORDER	CLOSE BRK1	POS 1 ORDER	POS 1 ORDER	POS 1 ORDER
	Output 2	POS 2 ORDER	CLOSE BRK2	POS 2 ORDER	POS 2 ORDER	POS 2 ORDER
	Output 3	POS 0 ORDER	OPEN BRK1	-	-	POS 0 ORDER S1
	Output 4	FORCED SHEDDING (C65) <sup>(1)</sup> S1 AVAILABLE (C55)	OPEN BRK2	-	-	POS 0 ORDER S2
	Output 5	LIFT (C65) S2 AVAILABLE (C55)	-	-	-	-
	Output 6	GENSET START	-	-	-	-
	Logic	Impulse <sup>(2)</sup>	Impulse	Maintained	Impulse	Impulse

<sup>(1)</sup> See chapter specific functions for more details.

<sup>(2)</sup> Impulse duration and length and number of retries can be configured in "MAIN MENU" > "PARAMETERS" > "NETWORK" > "APPLICATION".

All inputs and outputs can be configured and functions can be changed by going in "MAIN MENU" > "PARAMETERS" > "I/O".  
For the cabling, please consider the following table of functioning:

Controller config		STATE (relay)	Cabling Output relays 1-4		Cabling Output Latching relays 5 & 6	
			OUT 1 Normally Open (NO) (11-14)	OUT 1 Normally Closed (NC) (11 - 12)	OUT 6 Normally Open (NO) (61-64)	OUT 6 Normally Closed (NC) (61-62)
Output configured as NO	OFF (not active)	Open	Closed	Open	Closed	
	ON (activated by firmware)	Closed	Open	Closed	Open	
	Controller not supplied	Open	Closed	Closed*	Open*	
Output configured as NC	OFF (not active)	Closed	Open	Closed	Open	
	ON (activated by firmware)	Open	Closed	Open	Closed	
	Controller not supplied	Open	Closed	Closed*	Open*	

\* The ATyS C55/C65 include two bi-stable relays with backup energy, when the controller loses all sources of power supply (DPS, DC supply), the outputs 5 & 6 will activate using their independent backup power after the fail timer has timed out or 60s max from power failure detection. This is a safety feature is designed to ensure power availability to the load in Main-Genset or Genset-Genset application by forcing generators to start in case of total power loss.  
It is highly recommended to configure the outputs 5 and 6 Normally Open (NO) in order to benefit from this function.

# 10. FIRST POWER UP – SMART WIZARD

Once the controller is connected to the switch with the cable harness, as soon as the controller is powered up, it will automatically start in MANUAL mode and, in order to facilitate the commissioning, a smart wizard will appear to drive the user through the main configuration parameters.



The first out of 8 questions will be the language. User can choose between the following 9 languages:

- English
- French
- German
- Italian
- Polish
- Spanish
- Turkish
- Chinese
- Portuguese

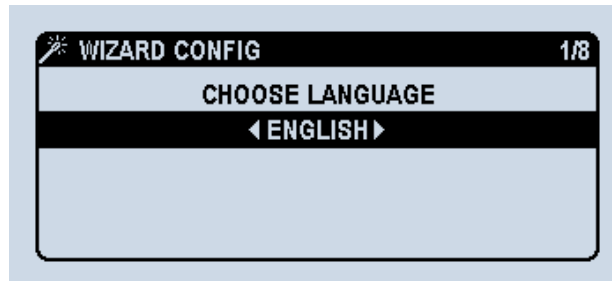

Then it will follow the option to start the wizard with the following options:

- Start now (will start the assisted configuration now).
- Remind me the next power on (will prompt user to go through the configuration during the next controller power up).
- Never ask me again (will not prompt user again).

The wizard will always be accessible anyway in "MAIN MENU" > "PARAMETERS" > "WIZARD" in case it is missed the first time.



If "NOW" is selected, then the options are:

- To use the smart configuration: parameters like voltage, frequency and phase rotation will be auto detected and user will be able to validate or modify the detected values.
- To use the manual configuration: user will enter manually all network configuration values.

The controller will require the configurator 4-digit password before the configuration (by default, 1000).

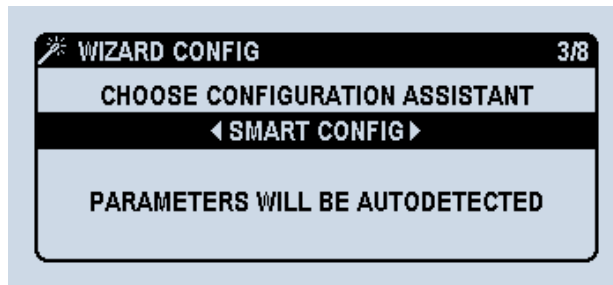

Once the configuration starts, the user needs to enter the date format, date and time as follows:

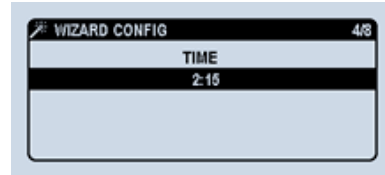
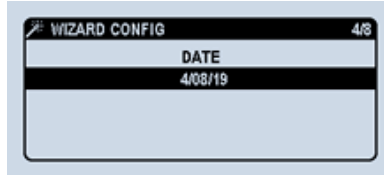
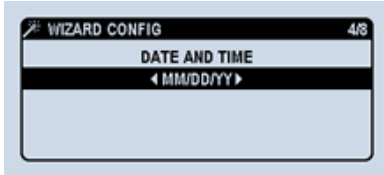

These time/date values will be saved and from that moment the RTC battery will keep the clock running even if the supply to the controller is lost.

Once these parameters are set, the next step is the sources settings, where the user has to confirm the values proposed by the controller (in case of smart configuration) or enter the values (in case of manual configuration) for the number of poles of the switch / wires coming from the sources, nominal voltage, nominal frequency and phase rotation.

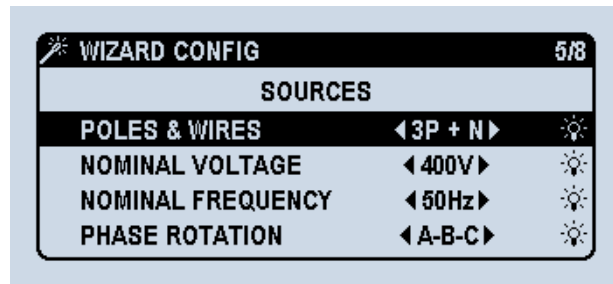

This is followed by the installation parameters.

Application type stands for the type of sources coming to the controller. The options are:

- Main-Genset (by default): Power supply coming from a transformer as source 1 and from a diesel generator as source 2.
- Main-Main: Power supply coming from a transformer for both sources 1 and 2.
- Genset-Genset: Power supply coming from a diesel generator for both sources 1 and 2.

Source priority stands for the preferred source in automatic mode when both sources are fully available.

The options are:

- Source 1: the source connected to source 1 sensing on the switch will become the preferred source and the transfer switch will automatically transfer to this source as long as it is available and the timers are respected.
- Source 2: the source connected to source 2 sensing on the switch will become the preferred source and the transfer switch will automatically transfer to this source as long as it is available and the timers are respected.
- No priority: no preferred source. The switch will stay in the same source as long as it is available and will only transfer automatically when it will be lost. In case a source comes back the switch will not transfer automatically as long as the current source is available.

**i** Note: in Main-Genset it is possible to connect either the transformer or the genset to both source 1 or 2 the source set as priority source will be assigned to the transformer (not possible to set No Priority in Main-Genset application).

**!** CAUTION ! Make sure that the settings are matching your installation for the correct functioning of the transfer switch.

Switch technology stands for the type of switch used with the controller. The options are:

- ATyS r/d: to be selected when using a motorized RTSE such as ATyS r, ATyS d/dM/dH, ATyS S or ATyS UL.
- CONTACTOR: to be selected when using 2 separated circuit contactors.
- CIRCUIT BREAKER: to be selected when using 2 separated circuit breakers / air circuit breakers (MCCB or ACB).
- ATyS FT / OPEN TRANSITION: to be selected when using an open transition single operator power contactor switch with 2 positions: I-II. In this configuration, the in-phase transfer & monitoring will be automatically enabled.
- ATyS DT / DELAYED TRANSITION: to be selected when using an delayed transition dual operator power contactor switch with 3 positions: I - center off – II. In this configuration, in-phase transfer is disabled by default.

The technology chosen will automatically configure the INPUTS and OUPUTS (see values by default in chapter "9.6.1. Command circuits", page 25 and I/O detail in chapter "I/O parameters menu", page 58) but they can always be modified in the menu "PARAMETERS" > "I/O" later on.

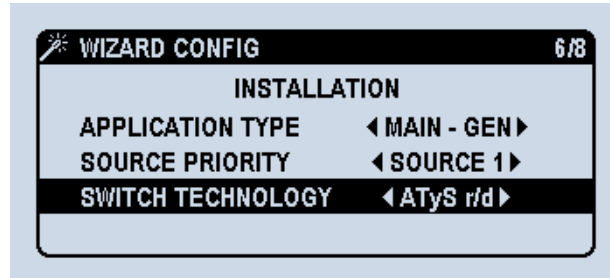

The 7th step will not affect the functioning of the transfer switch but allows the user to select a name for the product. Default name is ATyS C55/65, but it can be changed to any combination of letters, numbers and signs, for instance, "Cooling", "Line 1" or "DTC/21".

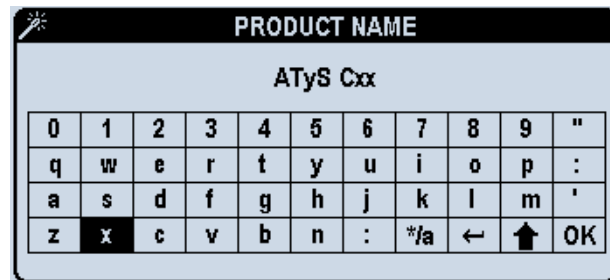

To finalize the configuration, the wizard asks for the communication parameters, such as the slave address (by default 6) and the communication parameters:

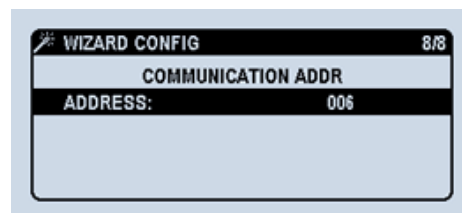
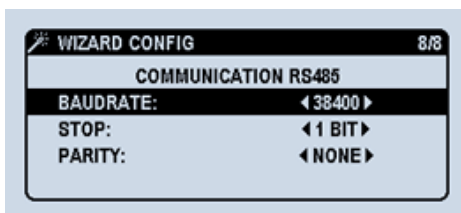

After entering and confirming these parameters, the wizard informs that the minimum parameters needed for the transfer switch to work are set and invites to go to the menu home screen where the user can set more parameters and functions manually (see next chapter).

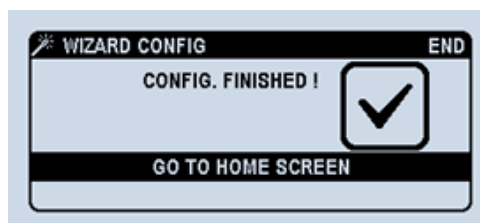

Note: for a detailed configuration please consult chapter "14. Configuration", page 46

# 11. VISUALISATION OPTIONS

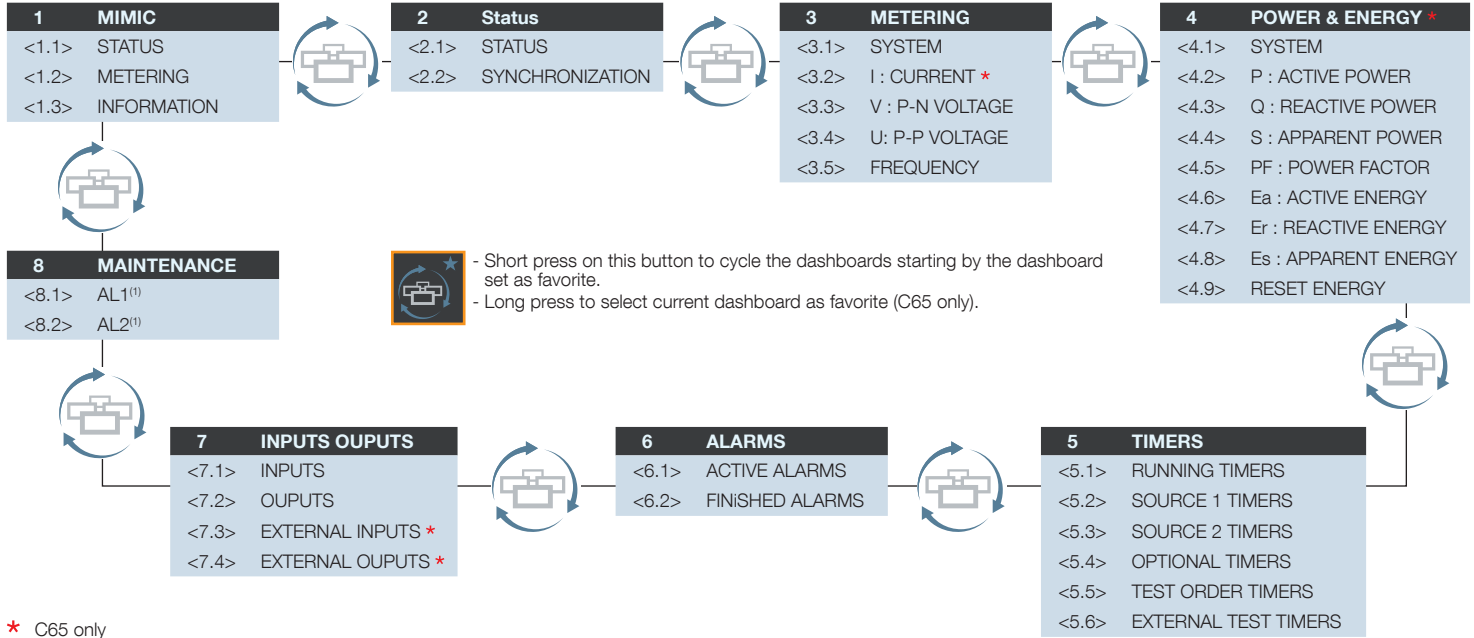

## 11.1. The visualisation DASHBOARDS

The controller has a direct access button to the visualisation dashboards on the front face. The dashboards can be accessed by short pressing the  key. By pressing again we switch from one dashboard to another and inside each dashboard there might be different number of screens as it is shown on the image below. Each dashboard is numbered from 1 to 7 (Ex. 3.1 METERING) and the screens are numbered using a second digit (Ex. 3.1 METERING - SYSTEM).



\* C65 only  
 (1) Maintenance alarms must be configured for this menu to show any values.

The dashboards can be visualized and screened through without the use of a password (any configuration or action requires the use of passwords so using dashboards is a risk-free solution to visualize the state of the product).

By pressing the  key it gives direct access to these screens (no matter the current menu screen), starting by the screen selected as favorite. On C65 only, to select a screen as favorite maintain the  pressed for 1,5 seconds (long-press) while the screen is shown\*. When a dashboard screen is selected as favorite (only ATyS C65) the star in the top right hand corner will be shown filled: .

\*This is available only for the screens of the dashboard menu

All the dashboards have the same display format as follows:

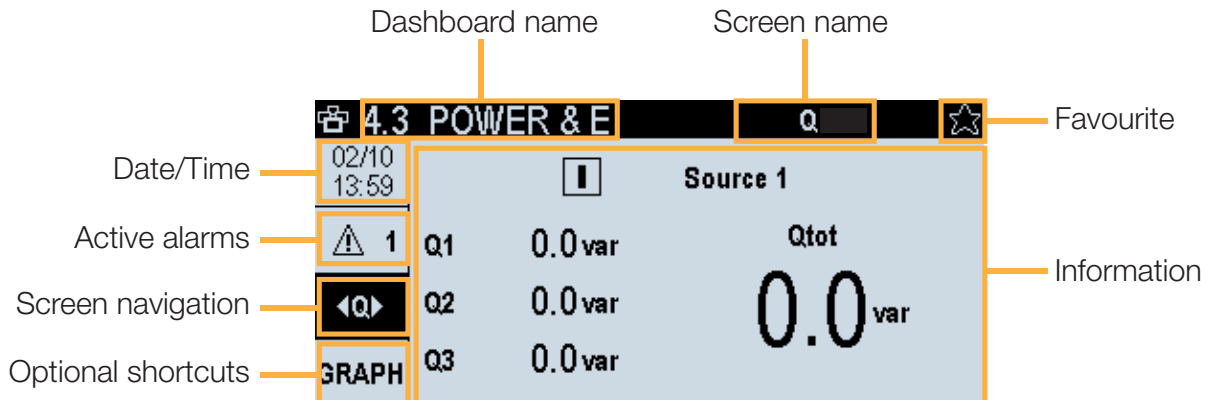

## 11.2. Mimic

This screen gives the user information on the availability of the sources, the position of the switch. The user can cycle 3 sub-menus using the navigation arrows:

MET.: gives the user information on the voltage, current and frequency of the sources.

STAT.: gives the user information on the sources and loads.

INFO.: gives information on the time running of each source.

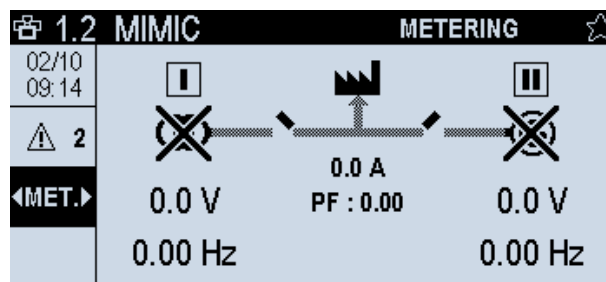
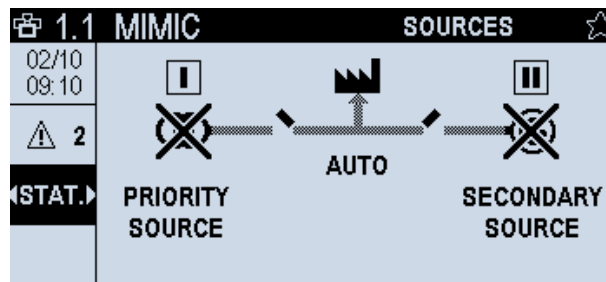

On the Summary display a mimic shows the status of the switch and the supply to the load. The sources will appear crossed if they are not available and not crossed if they are on. This information is also detailed in the status screen 2.1.

## 11.3. Status

Give more detailed information on the sources

STAT: informs the user on the availability of each source.

SYNC: Information on the voltage, frequency and phase angle of both sources.

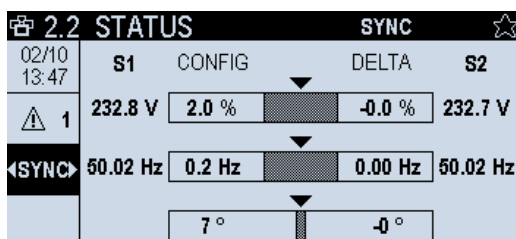
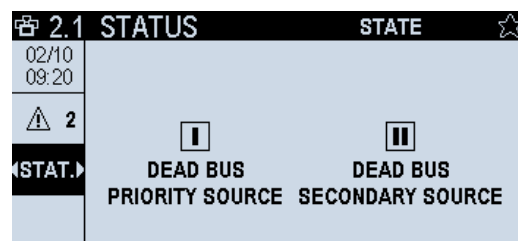
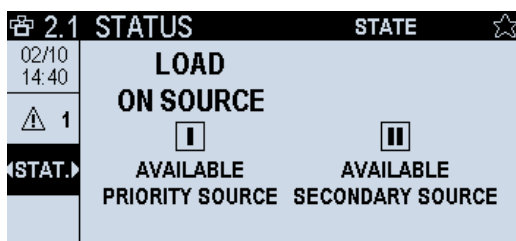

## 11.4. Metering

Allows the user to visualize detailed metering information on the load side.

U: Phase –Phase voltage.

V: Phase-Neutral voltage.

F: Frequency.

SYS: Voltage, frequency and current of the system.

I: all currents measured (current sensors need to be connected to use this function).

3.1 METERING		SYS	
02/10 13:52			
⚠ 1	I <sub>sys</sub> 0.0A		
◀SYS▶	V <sub>sys</sub> 233.1V	233.1V	
	F 50.0Hz	50.0Hz	

## 11.5. P&E

Allows the user to visualize the power and energy used by the load. (Current sensors must be used to enable this function). The information can be shown in numerical or both numerical and bar graph.

SYS: System information including P<sub>tot</sub> (total active power used), Q<sub>tot</sub> (total reactive power used), S<sub>tot</sub> (total power used) and PF<sub>tot</sub> (power factor).

P: Active power phase by phase.

Q: Reactive power phase by phase.

S total apparent power phase by phase

Pf: Power factor phase by phase.

Ea: Active energy.

Er: Reactive energy.

Es: Apparent energy.

RST E : Resets the energy measured.

4.3 POWER & E		Q	
02/10 13:59		Source 1	
⚠ 1	Q1 0.0var	Q <sub>tot</sub>	
◀Q▶	Q2 0.0var	0.0	var
GRAPH	Q3 0.0var		

4.3 POWER & E		Q	
02/10 14:03		Source 1	
⚠ 1	Q1	0.0var	
◀Q▶	Q2	0.0var	
GRAPH	Q3	0.0var	
	Q <sub>tot</sub>	0.0var	

4.1 POWER & E		SYS	
02/10 13:55		Source 1	
⚠ 1	P <sub>tot</sub> 0.0W	PF <sub>tot</sub>	
◀SYS▶	Q <sub>tot</sub> 0.0var	0.0	
	S <sub>tot</sub> 0.0VA		



## 11.6. Timers

Allows the user to visualize the status of the timers.

RUN: Shows all the ongoing timers, and allows the user to bypass the timers

S1: Shows all timers linked to source 1

S2: Shows all timers linked to source 2

OPT: Shows all optional timers

5.1 TIMERS		RUNNING	
02/10 09:24		Source 1 Failure	00:56:18
		Source 2 Failure	00:56:18
▲ 2			
◀RUN▶			
Bypass Timer			

The Bypass Timer option will allow user to Bypass the first timer in the list with the use of a password (OPERATOR or above).

## 11.7. Alarms

Allows the user to visualize active and finalized alarms. It also has a shortcut by pressing OK to go to the Alarms menu and clear alarms (password protected: operator).

ACT: Shows all active alarms, and allows the user to direct access to the alarm menu.

FIN: Shows all finalized alarms that are not acknowledged by the user.

In this screen, a direct access to the alarm log is available by pressing “down arrow” + “ok”, which will select the GO TO ALARM (Requires password OPERATOR or above) access in the left bottom of the screen. See more information about the alarm LOG in chapter "Log Menu", page 41.

6.1 ALARMS		ACTIVE	
02/10 09:28	TYPE	ALARM NAME	DATE/TIME
	Warn	RTC LOW BATT	01/15/21 14:49:13
▲ 2			
◀ACT▶			
GO TO ALARM			

## 11.8. I/O

Allows the user to visualize the configuration of the I/O. The settings for the inputs and outputs on the controller will be shown as well as the external I/O modules (if being used).

IN: Controller inputs.

OUT: Controller outputs.

E.IN: External inputs (IO10 modules).

E.OUT: External outputs (IO10 modules).

7.1 I/O		INPUTS	
02/10 09:34	1	SWITCH IN POS 1	ACTIVE
	2	SWITCH IN POS 2	OFF
▲ 2	3	NONE	OFF
	4	NONE	OFF
◀IN▶	5	NONE	OFF
	6	NONE	OFF

## 11.9. Maintenance

Allows the user to visualise the progression and state of the maintenance alarms. If no maintenance alarms are configured this dashboard will only show "NO MAINTENANCE ALARM CONFIGURED".

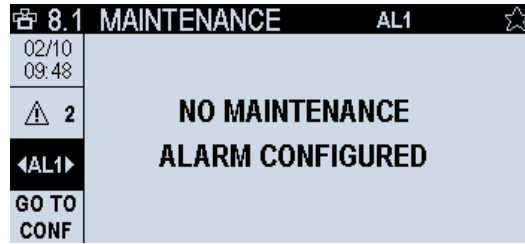

Pressing ok on "GO TO CONF" will lead to the maintenance alarm configuration menu, this will require the maintenance password.

## 11.10. The visualisation POP-UPS

The controller will inform the customer about the main real-time events through a pop-up. This pop-up can have 2 types of purpose:

- Timer running: timer pop-ups show the name of the timer active, the configured value and the countdown value with double font. This is a dynamic pop-up that gives 2 options to the user: BACK to ignore (hide the pop-up but the timer will keep running and can be seen in the TIMERS dashboard) or OK to bypass (skip the timer and go directly to next action; this can also be done through the input BYPASS TIMER or with a modbus command; input and command can only work while pop-up is displayed)- Bypassing the timer will request a validation.

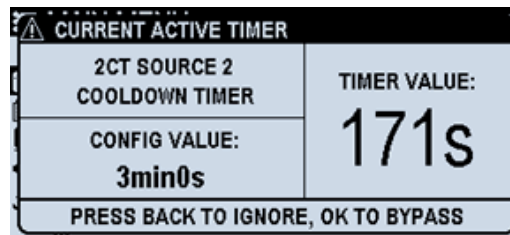

- Validation / Action requested: different events can use this type of pop-up, such as fault clearing, confirmation to run a test, confirmation to change parameters, validation to bypass a timer,... Usually these type of pop-ups can be ignored by pressing the BACK button and some of them offer different options to the user.

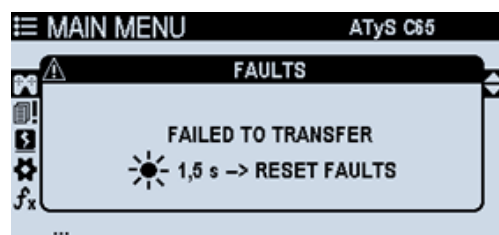

While it is not recommended to do so, it is possible to disable timer or alarm or both pop-ups. To change the configuration go to "MAIN MENU" > "PARAMETTERS" > "DISPLAY" > "OPTIONS" > "POPOP DISPLAYED".

**i** Note: if timer pop-ups are deactivated the function to bypass current active timer with inputs or communication will not be functional. (bypass timers through the TIMER dashboard will still be functional).

# 12. OPERATION AND CONTROL

## 12.1. HMI use

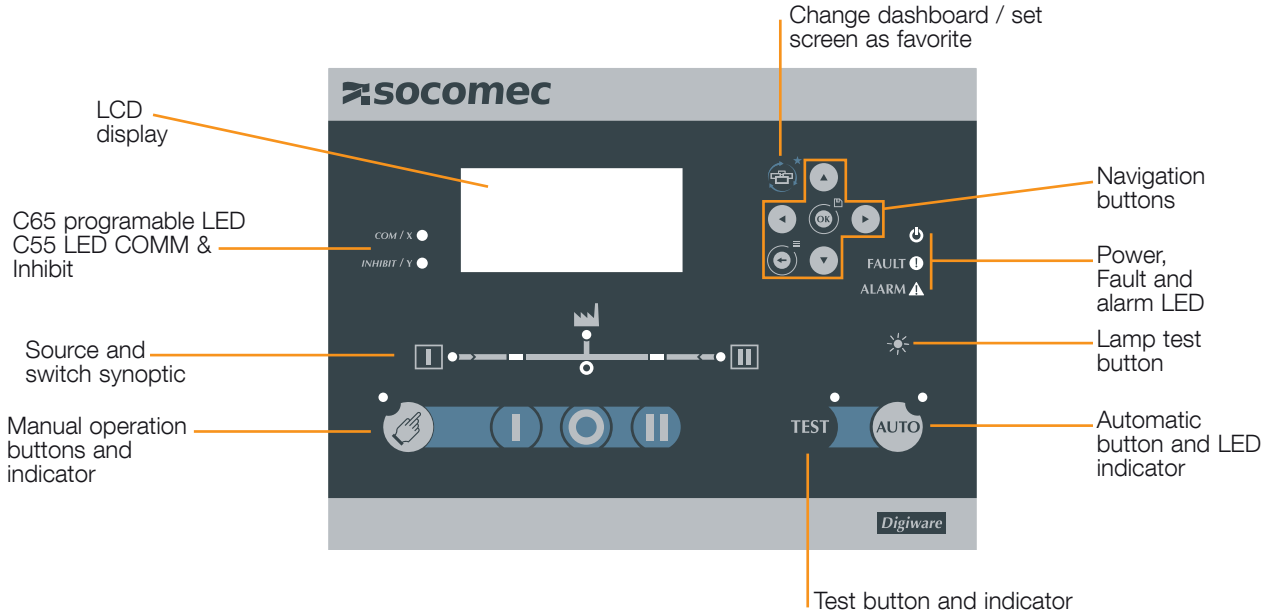

On the front face of the controller there are 14 keys/buttons that are used to configure, operate and visualise the ATS values anytime.

Summary of the HMI buttons



BUTTON	OPERATION
Manual	Turns on CTRL mode. Allows the use of the I, 0, II buttons that will send position orders to the switch.
Automatic	Turns on AUTO mode. Controller will automatically perform transfers in case of priority source unavailability and priority source comeback.
I	Position I (source 1) manual order. Only in CTRL mode.
0	Position 0 (center-off) manual order. Only in CTRL mode.
II	Position II (source 2) manual order. Only in CTRL mode.
TEST	Performs a TEST (as defined inside Parameters/Display/Options menu)
Arrows	Navigation through different screens, menus, options and values.
Lamp Test/Fault clear	Press: lamp test and information about LED on screen Long press: Clear faults pop-up (only if faults active)
Back/Menu	Press: back/return to previous screen or clear pop-up Long press: Back to Main Menu page
Dashboard/Favourite	Press: Go to the favourite Dashboard / Change between dashboard type (1 to 8, in a loop) Long press: Sets the current dashboard screen as favourite (C65 only)
OK/Save & Quit	Press: Enter / OK / set a value / accept / confirm Long press: (only when configuring) Save and Quit (back to previous configuration screen)

## 12.2. Navigation Menu

The Menu on the display can be accessed with the Return/Menu button  on the front face of the controller (if a menu other than dashboard or home screen is active press this button multiple times or hold for 3 seconds). It is structured in different chapters and is easy to navigate through it with the navigation pad. To select a screen use the navigation arrows , then press the ok key  to validate the selected screen.

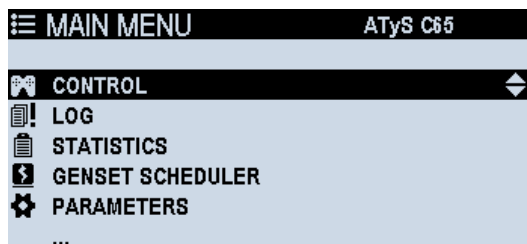

- CONTROL** – This menu allows to change the operation mode as well as to test position orders and engine start signals. (See chapter "13.1. Control Menu", page 40).
- LOG** – In this menu, the operator can see the list of past events, search an event by date (C65 only), and manage faults and alarms. (See chapter "13.2. Log/event history", page 41).
- STATISTICS** – This menu gives users information on the use of the ATS system such as, number of cycles, runtime on sources etc...
- GENSET SCHEDULER** – The operator can set different customized engine start programs and schedule them in a cyclic or non-cyclic mode. (See chapter "Genset scheduler / Engine Exerciser Menu", page 43)
- PARAMETERS** – In this menu all the configuration parameters of the ATSE can be set, as well as timers, communication, alarms, I/O and display parameters. Passwords and specific functions can also be set in this menu. (See chapter "Configuration through the display", page 46)
- SPECIFIC FUNCTIONS** – All functions that are specific for the controller are inside this menu. See all the options in chapter "SPECIFIC FUNCTIONS Menu", page 68
- MAINTENANCE** – This menu is reserved for maintenance purposes (service team). (See chapter "Maintenance of the controller", page 79)
- ABOUT** – The main information of the controller is showed on this menu: product serial number, firmware, communication address and the maintenance telephone to call for the service.



The Home screen (Main Menu) can always be accessed by long-pressing the  button from any other screen.

## 12.3. Operating modes

The controller has 4 types of operation modes:

**Manual Operation (CONTROL mode):** it allows the user to take the control of the commands sent by the controller and the automatic procedure is disabled (Specific function timers such as DEADBAND timer will still be respected when transferring manually).

To enter manual mode, click the Manual operation button: 

The LCD will prompt the user to enter the operator password. The Manual mode LED will light up and the manual operation buttons will be enabled. Select  to switch to source 1,  to go to source 2 and  to go to center off position (if existing).

 Note: in manual mode, if a source is lost, the genset (if any) will start but the controller will not force a transfer. The purpose is to keep the supply of the control and the communications.

**Automatic Operation:** in automatic mode the controller will take the control over the switching device according to the settings (operating range, timers, etc).

To switch from manual mode to Automatic mode, make sure there are no external inhibitions to automatic mode (inputs, cover open, etc..) and click the automatic operation button: 

The LCD will prompt the user to enter the operator password. The automatic mode LED will light up.



The switch may transfer as soon as automatic mode has been enabled.

**Test Mode:** This allows an authorized maintenance person to initiate a transfer to the backup source (default Source 2) and to decide when to go back to the priority source (default Source 1). The test can be initiated in the "TEST" menu located in "MAIN MENU" > "CONTROL", user can select a NO LOAD TEST (to start the generator only with no load transfer) or LOAD TEST (start the genset and transfer the load).

The test can also be initiated directly by pressing the "TEST" button on the HMI, by default this button will launch a LOAD TEST but this button can be changed to NO LOAD TEST in the menu TEST BUTTON USE in "MAIN MENU" > "PARAMETERS" > "DISPLAY" > "OPTIONS". The TEST mode can be launched from both MANUAL or AUTOMATIC modes.

To switch to TEST mode, make sure there are no external inhibitions and click the automatic operation button: 

The LCD will prompt the user to enter the operator password. The TEST mode LED will light up.



The switch may transfer as soon as TEST mode has been enabled, respecting the elevator timers, in-phase timers (for open transition switches with positions I-II) and center-off position timer (if the switch has a 0 position).

**Inhibit Mode:** This mode is activated in case of major faults or with inputs such as switch cover open or during maintenance operations. In inhibited mode the switch will not be operable using the controller.

These modes can also be selectable through the display in the CONTROL menu, through inputs or through communications; LED will indicate the state of the switch.



**Note: to change the operation mode, a password might be required.**

## 12.4. Availability conditions

There are 3 different status for the sources:

- Busbar dead
  - No voltage present on the source (all voltages below 50V).
- Source present
  - Voltage present (at least 1 phase above or equal to 50V) but availability conditions are not reached (see "Source available" below)
- Source available
  - To consider the source available:
    - the voltage and frequency should be inside the limits set in the operating range
    - all phases should be present (according to the network configuration selected)
    - sources should not be set by an input as unavailable / inhibited
    - phase rotation should be ok (if check rotation is selected in the menu)

For phase / neutral wire loss detection :

- Loss of Neutral: will be detected in all cases except for balanced networks with balanced loads, in this case the controller will not detect the loss of the neutral connector unless the load has a minimum value of unbalance.
- Loss of Phase: will be detected in all cases.



**Note:** The controller will not detect any phase/neutral wire failure downstream of the switching device.

The synoptic on the C55/65 controller informs the user on the status of the sources:

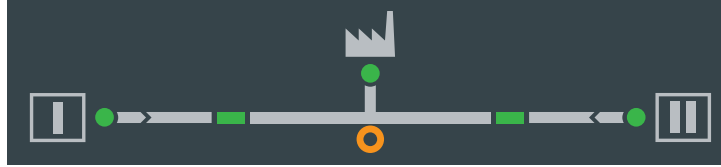

The round green LED next to S1 or S2 indicates if the source is available or not.

- If the LED is on but not blinking then the source is considered as available.
- If the LED is blinking, source is seen as present but not available.
- If the LED is off, then controller detects that the busbar is dead.

The 2 rectangle green LED indicates the position of the switch.

- If the LED is on, the switch is closed on that position (I or II).
- If the LED is blinking, the controller considers the switch is in that position, but there is no feedback from the switch (no inputs have been configured to this position).
- If the LED is off, the switch is not in that position.

The green LED in the center-up of the diagram indicates if the load is powered.

- If the LED is on, the load is supplied by either source 1 or source 2, which means that the source is available and the switch is in one of these positions.
- If the LED is blinking, the load is supplied but a load shedding is taking place.
- If the LED is off, the load is not supplied (switch not closed on an available source).

The "0" amber LED under the load LED indicates the center-off position.

- If the LED is on, the switch is in center-off position (only if there is a 0 position)
- If the LED is off, the switch position is either on S1, S2 or unknown (should always be off for technologies without 0 position)
- If the LED is blinking, the controller considers the switch is in that position, but there is no return from the switch (no inputs have been configured to the 0 position)



The state of the position LED is entirely dependent on the inputs programmed for position inputs. If no position inputs are programmed the position LED will blink based on the expected position of the switch (controller will expect that switching orders have been taken into account correctly by the switch immediately).

## 12.5. Test operating mode

TEST button on the HMI can be used to perform a TEST ON LOAD (default setting) or TEST OFF LOAD (this requires a change of configuration in the field TEST BUTTON USE in "MAIN MENU" > "PARAMETERS" > "DISPLAY" > "OPTIONS").

TEST ON LOAD : a test on load sequence will start by sending a start-gen signal to the secondary source (if in Main-Gen) , and will initiate a transfer to the the secondary source, once the test has ended the switch will transfer back to the priority source.

A TEST OFF LOAD will initiate starting of the genset but will not give the order to transfer to the secondary source when it becomes available.

The duration of the tests can be limited (in the configuration) or can be set to Unlimited, when set to unlimited the user will have to press the test button again to stop the tests..

This operation can also be performed with an input or through the Modbus communication, using the EXTERNAL TEST ON LOAD function.



TEST ON LOAD will cause a load supply interruption when testing the transfer function as the load will change from one source to another in open transition.

For more information on the tests sequence see "Annex 16 - 5. Operating sequences", page 96.

# 13. MAIN MENUS DETAILS

## 13.1. Control Menu

There are 3 types of commands available in the control menu and all of them require the operator profile password. Those commands are:

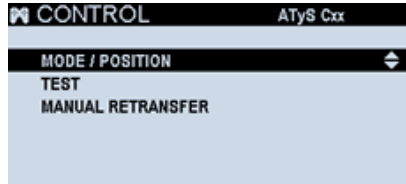

- MODE / POSITION: permits changing the operating mode, change position in CTRL mode and start/stop the gensets remotely (also in CTRL mode)

- MODES:

- AUTOMATIC: Standard automatic functioning of the controller
- CONTROL (MANUAL): Control of the switch manually using the controller to give orders to the switch. Buttons I-O-II are unlocked on the front face.
- INHIBIT: Both CONTROL and AUTOMATIC functions are inhibited until the mode changes (both automatic transfers and manual orders through pushbuttons will be inhibited). The information that the switch is inhibited will be shown on dashboards 1.1 and 1.3 and the "INHIBIT" LED on the C55 will light up (X & Y LED on C65 if programmed to "INHIBIT MODE"). To leave this mode change to AUTOMATIC or CONTROL in the COMAND MENU or using the AUTO / MANUAL pushbuttons.
- PARTIAL INHIBIT: Both CONTROL and AUTOMATIC functions are inhibited until the mode changes, but the genset start signal will be activated if the priority source is lost.

**i** Note: total inhibition (to block the use of the AUTO & MANUAL pushbuttons) can only be launched through modbus or programmable inputs.

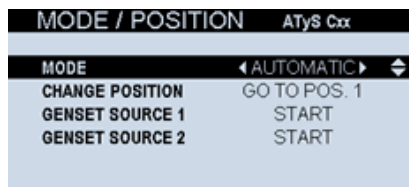

- CHANGE POSITION: (only in CONTROL mode) permits sending orders to go to position 1, 0 (center-off) or 2 to the switch device.
- GENSET SOURCE 1/2: permits START or STOP the gensets installed as source 1 or 2.

**i** Note: the MODE / POSITION menu is an "order" menu, to activate commands, but it doesn't show the current mode or position (to visualize that the user needs to go to the dashboard screens, or using the LEDs on the HMI). Example: mode can be inhibited, but when entering the menu the mode will say "automatic" (which is not the current mode, it is possible orders to be used).

- TEST: permits launching a TEST ON LOAD or a TEST OFF LOAD. See chapter "12.6. Test operating mode", page 39.

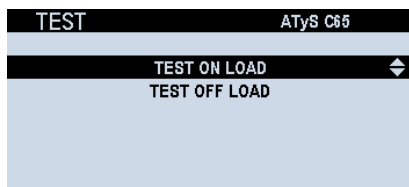



- MANUAL RETRANSFER: when “manual retransfer” option is activated in "SPECIFIC FUNCTIONS" > "MANUAL RETRANSFER", the operator will need to validate the retransfer (directly on the HMI as shown below using the pop-up window when prompted by the controller or using external inputs) the retransfer from alternate/secondary to priority/preferred/primary source by pressing OK and confirming in this screen.

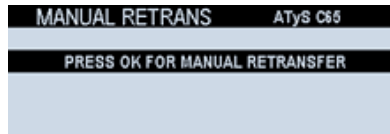

## 13.2. Log/event history

The LOG menu contains all the history/register/log of EVENTS (operations, timers, mode changes, configuration changes, product status, source availability..) ALARMS (user-selectable alerts) and FAULT (major alerts, not selectable by user, set by default). All the LOG menu elements are protected by the “operator” password (see chapter "14.1.8. PASSWORDS", page 67).

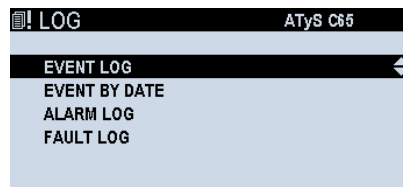

- EVENTS LOG: The controller C65 can store up to 3000 events while the C55 can store up to 300 events using FIFO (first in, first out) to replace older events when the memory is full.

The event log will show the information of virtually everything happening on the controller/ATS with timestamp and description. More information is available on the Webserver integrated on DIRIS Digiware M-70 gateway (detail of every event). To navigate through the event log, the UP and DOWN arrows can be used to advance on the event list one by one and the LEFT and RIGHT arrows to advance 6 events every time.

As the controller can host a large number of registers in the log, the EVENT BY DATE functions is a search engine that permits to go directly to a selectable date and time and see the events that took place at that moment (C65 only).

EVENTS LOG	ATyS Cxx
Phone number changed	04/08/19 08:14:42
S2 Not Started	04/08/19 08:14:31
S2 Wait for Start Timer Stop	04/08/19 08:14:31
S2 Lost	04/08/19 08:14:00
S1 Lost	04/08/19 08:14:00
S2 Underfrequency	04/08/19 08:14:00

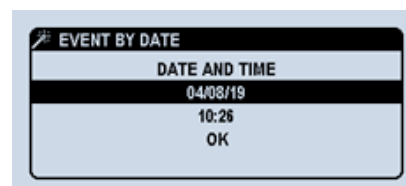

- ALARM LOG: the log can store up to 100 alarms or faults. Inside alarm log screen, there are 2 options: in progress and history. “In progress” shows all active alarms and the history shows all the last finalised alarms.

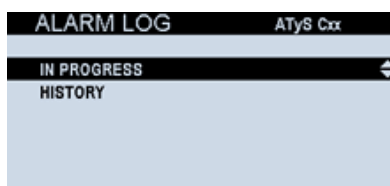

For each alarm, the following information will be shown:

- Type of alarm
- Status
- Starting time and date
- Duration of the alarm active (counter running for active alarms)
- Criticality of the alarm

To learn about alarm configuration and options (see "14.1.7. ALARMS parameters menu", page 63).

IN PROGRESS		ATyS Cxx
-	-	↕
-	-	
-	-	
-	-	
-	-	

HISTORY		ATyS Cxx
EXTERNAL ALARM	04/05/19 10:28:24	↕
EXTERNAL ALARM	04/05/19 10:24:28	
EXTERNAL ALARM	04/05/19 10:03:57	
Measure Alarm 1	04/05/19 10:00:18	
Measure Alarm 1	04/04/19 10:06:59	

- FAULTS: 100 registers of faults and alarms can be stored inside the internal memory and they are divided into "in progress" and "history". Faults, however, permit also resetting faults using the option "PRESS OK TO RESET FAULTS" and confirming on the pop-up that appears on screen.

FAULTS		ATyS Cxx
IN PROGRESS		↕
HISTORY		
PRESS OK TO RESET FAULTS		

FAULTS		ATyS Cxx
PRESS OK TO RESET FAULTS		

Faults, to the contrary of alarms, have no detail of each register. On the history log, the information is the fault description and the time & date when it occurred.

HISTORY		ATyS Cxx
GENSET FAILSTART	04/08/19 08:14:32	↕
GENSET FAILSTART	04/08/19 07:36:28	
UNEXP TRANSF	04/05/19 09:29:27	
TRANSF FAIL	04/05/19 09:28:55	
GENSET FAILSTART	04/05/19 09:27:27	

### 13.3. Statistics menu

This menu details counters for:

- Cycles (operating hours, number of cycles, cycles in manu, cycles in auto)
- Operations (total and for each position)
- Running hours (total and partial) (partial can be reseted by user)
- Source 1 / Source 2 data (total time in source, partial time, last switch, total time on load)
- Genset 1 / Genset 2 data (total active time, total active time on load, genset start counter)
- Breaker : Number of trips and date of last trip

STATISTICS		ATyS Cxx
OPERATING HOURS	6 d 46 min39s	
CYCLE CNT	27	
TOT CYCLES IN AUTO CNT	5	
TOT CYCLES IN MANU CNT	22	
-		
GENSET 2 <- CYCLES -> OPERATIONS		

## 13.4. Genset scheduler / Engine Exerciser Menu

There are 4<sup>(1)</sup> selectable engine exerciser programs that are set in order of priority on the display. Meaning that the program “CUSTOM 1” is priority over the “CUSTOM 2” if both tests are scheduled to occur at the same time. This is to avoid exercising a genset that is already being exercised.

<sup>(1)</sup> Only for ATyS C65, ATyS C55 has 1 Custom engine exerciser program

SCHEDULER	
ATyS C65	
GENERAL PARAMETERS	
CUSTOM 1	
CUSTOM 2	
CUSTOM 3	
CUSTOM 4	

 GENERAL PARAMETERS includes a GENSET IDLE TIMEOUT setting, this setting dictates the time for which the genset must be off before another automatic test can be launched (this includes automatic and manual starts on the genset), if the amount of time configured has not passed the Custom test will not be launched. As standard this parameter is set to 0min to follow strictly the custom programs and can be configured up to 60 000min.

For each program (CUSTOM 1-4), the following settings can be defined individually:

- **Type of test:** type of test that will be performed on this program
  - TEST ON LOAD / LOAD TEST: will perform a full test including all the timers and operating the switch (full cycle).

 Note: on all switches, a TEST ON LOAD will cause a load supply blackout when testing the transfer function.

- TEST OFF LOAD / NO LOAD TEST: will perform a genset start for the defined time, and a genset stop after the time elapses.
- Nothing / NOT USED
- **Periodicity:** every how often will the program take place. It can be set yearly, semi-yearly (every 6 months), bimonthly (every 2 months), monthly, 28 days, biweekly (every 2 weeks), weekly, every 2 days, daily or NON CYCLIC (no repetition, single use).
- **Test Duration:** the time the generator will run with the load before transferring back to priority source (for example, 15minutes).

 **WARNING !** If using “Manual retransfer” specific function, the transfer to the main source will not take place when the test ends, but it will wait user validation to retransfer.

- **Starting time&date:** the date&hour when this periodic program will start (for example, starting on January 5th at 1pm). (date and hour when first TEST will take place)

CUSTOM 1	
ATyS Cxx	
TYPE SET	
PERIODIC SCHEDULE	
TEST DURATION (s)	
START DATE	
START TIME	
...	

\*Example:

- TYPE: TEST ON LOAD
- PERIODIC SCHEDULE: MONTHLY
- TEST DURATION (s): 900 (15min)
- START DATE: 05/01/21
- START TIME : 13:00

The exerciser program will do the following:

Exerciser will carry on a full test on load (starting genset if any, counting timers and operating the switch and transferring loads from priority source to alternate source) on Jan 5th at 1pm for 15 minutes. This will be repeated every month at the same time (1pm) for the following months.

In the case of overlapping several exerciser/scheduler programs, the priority one (lower custom number) will take place and not the others. Examples:

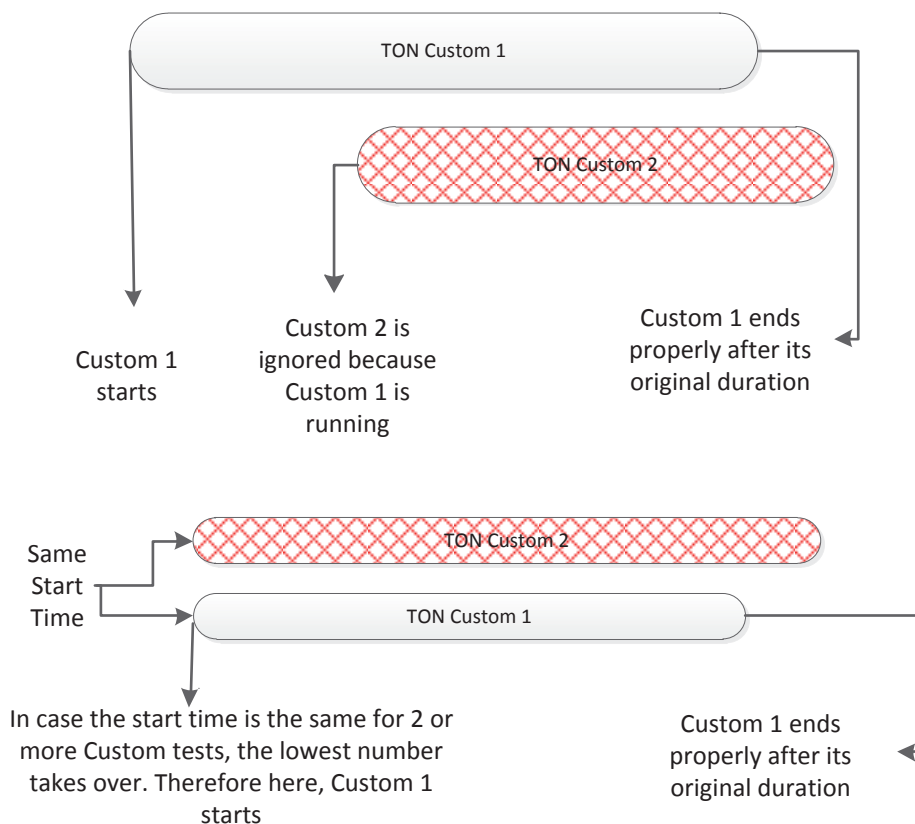

## 13.5. About

ABOUT		ATyS Cxx
PRODUCT TYPE	ATYS C65	
LAST INSPECTION	01/01/00 00:00	
SERIAL NUMBER	1910201001116000065	
FIRMWARE VERSION	2.1	
COMM ADDR	6	
MAINTENANCE TEL	000-000-0000	

About contains:

- Product type information (C55/C65)
- Date of last inspection which can be updated using the maintenance menu:  
"MAIN MENU" > "MAINTENANCE" > "INSPECTION DATE" (requires maintenance level password)
- Product serial number
- Product firmware version
- Modbus communication address
- Maintenance telephone which is shown in case maintenance is required on the product, this number is set to 000-000-000 as default and can be modified in the maintenance menu:  
"MAIN MENU" > "MAINTENANCE" > "INTRODUCE PHONE NUMBER"

## 13.6. Other main menus

The menus, parameters, specific functions and maintenance are detailed in the next chapter configuration.

For the full menu architecture see "Annex 16 - 7. Full menu architecture", page 101.

# 14. CONFIGURATION

The configuration on the ATyS C55/65 can be done:

- Directly on the HMI.
- By USB connection to the controller (using EasyConfig software, available for free download at [www.socomec.com](http://www.socomec.com)).
- Through communication (DIGIWARE or RS485).

 Note: The configuration can be done even without cabling the AC or DC supply to the controller, only connecting it to a computer with an USB cable. The controller will use the USB to power up the screen, buttons and main functions, permitting the configuration through any of these methods.

 For safety reasons, if the controller is connected to the switch, it is strongly recommended to configure in Manual or Inhibit mode.

## 14.1. Configuration through the display

How to configure the main parameters manually using the display:

### PARAMETERS MENU

Inside the PARAMETERS menu of the Main Menu (accessible by entering the Configurator password, by default 1000) all the main parameters of the controller can be set:

<b>NETWORK</b>	Configuration of the nominal voltage and frequency, the phase rotation, the type of switch and the sources priorities, as well as the operating range where the controller will consider a source as available. See chapter "NETWORK parameters menu", page 47
<b>LOAD</b>	Configuration of the nominal current and the transformers used to measure the current on the load side of the switch. See chapter "LOAD parameters menu (only C65)", page 53.
<b>DISPLAY</b>	Configuration for language, date&time. The test button use ("LOAD TEST" or "NO LOAD TEST") and X&Y LED configuration (C65 only). Product name and screensaver text. See chapter "DISPLAY parameters menu", page 54.
<b>TIMERS</b>	Configuration for operational timer. See chapter "TIMERS parameters menu", page 56.
<b>I/O</b>	Configuration of the Inputs and Outputs of the controller and the external I/O modules. See chapter "I/O parameters menu", page 58.
<b>COMMUNICATIONS</b>	Configuration of the communication parameters such as the Modbus address or the baudrate but also the use of the RJ45 outputs (Only on ATyS C65). See chapter "COMMUNICATION parameters menu", page 59.
<b>ALARMS</b>	Permits programming different alarm types that can be linked to outputs and will show the information on the screen of the ATyS C65 and on the webserver (only available with M70 or D70 gateways). See chapter "ALARMS parameters menu", page 63.
<b>PASSWORDS</b>	Permits changing the passwords for the different users. See chapter "PASSWORDS", page 67.
<b>WIZARD</b>	Allows user to go through the wizard configuration again.

 **Important Note: when doing the configuration through the display, do not forget to put the controller in AUTO mode after the configuration is over to start the AUTOMATIC mode.**

### 14.1.1. NETWORK parameters menu

The NETWORK menu allows the user with the Configurator profile to configure the installation parameters. Inside NETWORK, there are 5 different submenus:

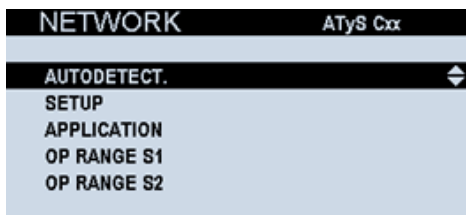

**AUTODETECT.** – When selected the function, a pop-up will show asking for a validation from the user to start autodetecting the network type, the nominal voltage and frequency and the phase rotation. After the autodetection the result can be consulted and modified in the SETUP menu. Information can be consulted on the SETUP menu.

**SETUP** – Settings concerning the installation can be configured here:

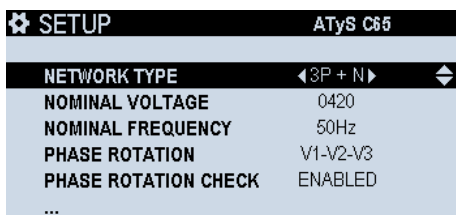

- NETWORK TYPE: number of poles and wires. See detail on page "Types of network" inside this chapter
- NOMINAL VOLTAGE
- NOMINAL FREQUENCY
- PHASE ROTATION (ABC or ACB // V1 V2 V3 or V1 V3 V2)
- PHASE ROTATION CHECK: This can be enabled or disabled. By default it is enabled but it can be disabled for applications where the user intentionally wants to do so. (Usually only for loads that are not affected by a change in rotation).
- VT USED: ("Used" or "Not used") When voltage transformers are used for certain applications with V levels above the maximum that the controller can measure directly (ph-ph: 576Vac). Example: 600/480V transformers for 600V Networks. This ratio must be added to the next two lines in parameters "VT primary" and "VT secondary".

 **WARNING !** In order to save the settings it's mandatory to select SAVE CONFIG on the bottom of the screen or press the "OK" button for 1.5s and a pop-up will appear asking for confirmation before "save & exit".

**APPLICATION TYPE** – Settings concerning the usage of the controller (which type of switch, type of sources, priorities...)

APPLICATION	ATyS
SWITCH TECHNOLOGY	◀ATyS FT▶
APPLICATION TYPE	MAIN - GEN
SOURCE 1 NAME	Source 1
SOURCE 2 NAME	Source 2
SOURCE PRIORITY	SOURCE 1
...	

- SWITCH TECHNOLOGY – Type of switching device / RTSE. Options are:

- ATyS r/d (remote / double supply) makes reference to any Socomec type ATyS r, ATyS d, ATyS dM, ATyS dH, ATyS S/Sd switches or equivalent motorized switch-based RTSE.
- ATyS FT (C65 only) – (fast transfer) makes reference to Socomec’s ATyS FT or equivalent Class PC 2 position (I-II) fast transfer (<50ms) switching device or equivalent. This technology permits using in-phase transfer (with C65)
- ATyS DT – (delayed transfer) makes reference to Socomec’s ATyS DT, dual operator Class PC with 3 position (I-center off-II) switching device or equivalent.
- CIRCUIT BREAKER – (MCCB or ACB) makes reference to standard IEC 60947-2 circuit breakers with 2 positions per device (ON and OFF), offering the option to have 3 positions when used as a transfer switch (I-0-II).
- CONTACTOR – (circuit contactor) makes reference to standard IEC 60947-4-1 contactors with 2 positions per device (ON and OFF), offering 3 positions (I-0-II). This technology forces the value of the parameter "LOGIC" to "MAINTAINED" meaning that the outputs with position orders will maintain the order active as long as the position is requested.

 Note: to make configuration easier, the controller automatically changes the I/O configuration for position orders (outputs) and position return feedback (inputs) from the switch (using preset values see chapter "Command circuits", page 25) according to the technology that will be set in the controller.

 Note: for safety reasons the change of technology can only be done in Manual mode and requires the configurator profile password.

- APPLICATION TYPE

- MAIN/MAIN or UTILITY/UTILITY when using 2 transformers as source 1 and 2.
- MAIN/GENSET or UTILITY/GENSET when using a transformer and a genset as sources (Transformer will automatically be set on the priority source - Default set to source 1).
- GENSET/GENSET when using 2 diesel generators / gensets as sources

- SOURCES NAME: user can enter a name for each source. By default "Source 1" and "Source 2"

- SOURCE PRIORITY: priority/preferred source can be set for source 1, source 2 or "no priority". In the "no priority" case, the switch will be closed on either one source or the other as long as they are available (in MAIN/GENSET mode it is not possible to select the source with genset as priority source)..

- LOGIC: according to the inputs of the switch to receive position orders, there are 3 types of logic:

- IMPULSE / PULSE: the output from the controller will send a pulsed signal with a defined duration to the switch to change position (pulse duration, number of retries in case transfer has failed and delay between 2 retries can be configured using the parameters in the same menu).
- SMART IMPULSE : The impulse will be maintained until the switch has achieved the requested position or for the maximum duration configured if the position is not reached before. If this option is selected there will be no retries if the switching fails.
- CONTACT / MAINTAINED: the output from the controller will close and stay closed indefinitely as long as the switch is requested to stay in a position. This logic is used mainly with contactors but also with breakers and class PC switches that accept it. In that case, for example, if position 2 order is activated it will close the output until the transfer, when the output will be off to switch to center-off / position 0 and after go to position 1.

- TEST / EXT TEST ON LOAD PRIO (yes/no): with this option, when a TEST is taking place, it will stay in test position until it finishes (timers are elapsed) even if the source is lost.

 Note: if the test is set as Unlimited, the switch will stay in test position until the user manually ends the test.



- RETRY NUMBER (0-10): While in IMPULSE logic, if the position is not reached after a first pulse of position order the controller will send the position order again (retry). After all retries have occurred if the intended position is still not reached the controller will detect this as a "FAILED TO TRANSFER" fault. If this value is set to 0 the controller will only send a single pulse when giving position orders.
- RETRY DELAY (600-10000ms): time interval between each retry. Minimum is always pulse length + 500ms, starts counting at the beginning of the impulse.
- PULSE LENGTH (100-5000ms): Duration of the pulse (only for IMPULSE mode). Indicates max pulse length in SMART IMPULSE mode.

**i** Note: in order to save the settings it's mandatory to select SAVE CONFIG on the bottom of the screen or press OK button for 1.5s and a pop-up will appear asking for confirmation before "save & exit".

OP RANGE S1 and S2 – Configuration menu for the limits of acceptability for the sources 1 and 2 respectively.

OP RANGE S1	ATyS Cxx
S1 OV FAIL (%)	115
S1 OV RESTORE (%)	110
S1 UV FAIL (%)	85
S1 UV RESTORE (%)	95
S1 UB FAIL (%)	00
...	

OP RANGE S2	ATyS Cxx
S2 OV FAIL (%)	115
S2 OV RESTORE (%)	110
S2 UV FAIL (%)	85
S2 UV RESTORE (%)	95
S2 UB FAIL (%)	00
...	

- OV= overvoltage
- UV= undervoltage
- OF = overfrequency
- UF = underfrequency
- UB = unbalance

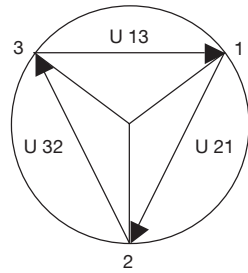

Balanced network

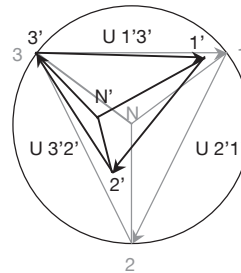

Unbalanced network

For each parameter, the limits can be set in % vs the nominal value and there are two parameters to set: the threshold value that will make the source be considered unavailable (FAIL) and the hysteresis value that will make the source be considered available again (RESTORE).

The thresholds and hystereses are defined as percentages of nominal voltage.  
The hystereses define return to normal levels following an under-voltage or over-voltage.

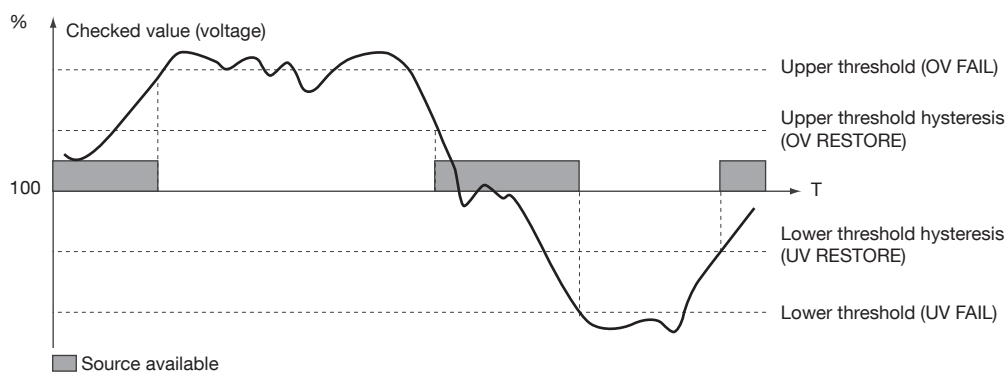

**i** Note: in order to save the settings it's mandatory to select SAVE CONFIG on the bottom of the screen or press OK button for 1.5s and a pop-up will appear asking for confirmation before "save & exit".

		DEFINITION	** ADJUSTMENT RANGE
OV FAIL	115%	Overvoltage threshold: Source Supply 1	102 – 130%
OV RESTORE	110%	Over-voltage hysteresis: Supply 1	101 – 129%
UV FAIL	085%	Undervoltage threshold: Supply 1	60 – 98%
UV RESTORE	095%	Undervoltage hysteresis: Supply 1	61 – 99%
UB FAIL	000%	Phase unbalance threshold: Supply 1 Refer to next paragraph for further details	0 – 30%
UB RESTORE	000%	Hysteresis unbalance threshold: Supply 1 Refer to next paragraph for further details	0 – 29%
OF FAIL	105%	Over Frequency Threshold: Source 1	102 – 130%
OF RESTORE	103%	Over Frequency Hysteresis: Source 1	101 – 129%
UF FAIL	095%	Under Frequency Threshold: Source 1	60 – 98%
UF RESTORE	097%	Under Frequency Hysteresis: Source 1	61 – 99%

\*\* Adjustment range given:

- As a % of U nominal for Over and Undervoltage
- As a % of U avg in case of unbalances.
- As a % of nominal frequency

## Types of Network

### 1P+N SINGLE PHASE NETWORK

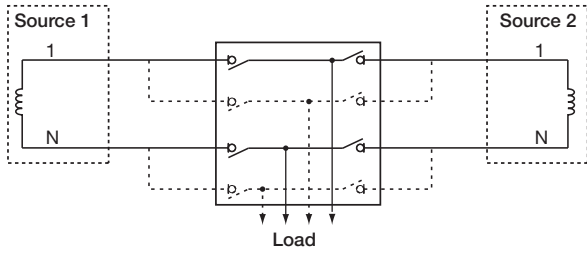

### 2P TWO PHASE NETWORK WITHOUT NEUTRAL

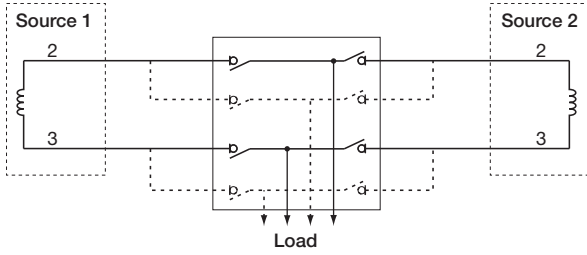

### 2P+N TWO PHASE NETWORK WITH NEUTRAL

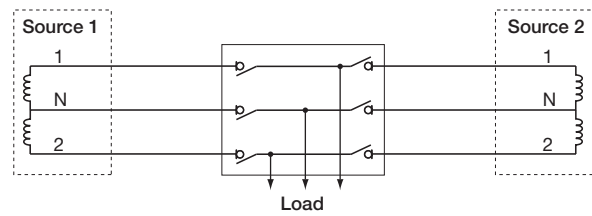

### 3P THREE PHASE NETWORK WITHOUT NEUTRAL

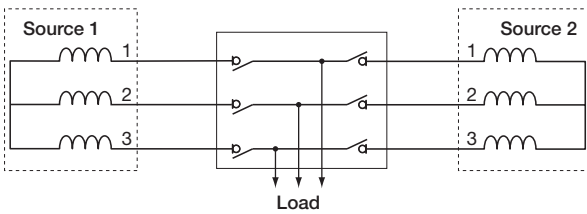

### 3P+N THREE PHASE NETWORK WITH NEUTRAL

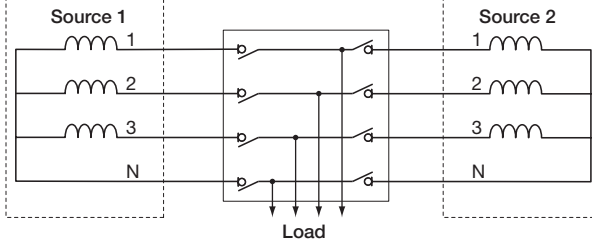

### 3P+N SOURCE 1: THREE PHASE NETWORK WITH NEUTRAL 1P+N SOURCE 2: SINGLE PHASE NETWORK WITH NEUTRAL

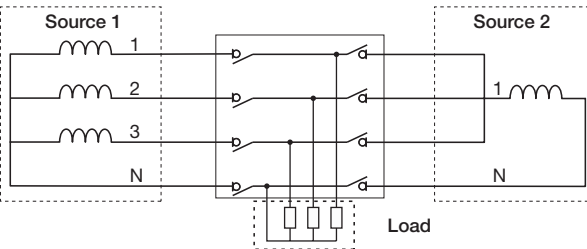

## Metering and sensing details

NETWORK TYPE						
	1P	2 P	2P+N	3P+N	3P+N	3P+N / 1P+N
Source <span style="border: 1px solid black; padding: 0 2px;">1</span>	1 phase 2 wire	2 phase 2 wire	2 phase 3 wire	3 phase 3 wire	3 phase 4 wire	3 phase 4 wire
Source <span style="border: 1px solid black; padding: 0 2px;">2</span>						1 phase 2 wire
Source <span style="border: 1px solid black; padding: 0 2px;">1</span>						
Source <span style="border: 1px solid black; padding: 0 2px;">2</span>						
CT cabling (load side)						
VOLTAGE SENSING						
Source <span style="border: 1px solid black; padding: 0 2px;">1</span>	- V1	U12	U12 V1, V2	U12, U23, U31	U12, U23, U31 V1, V2, V3	U12, U23, U31 V1, V2, V3
Source <span style="border: 1px solid black; padding: 0 2px;">2</span>	- V1	U12 -	U12 V1, V2	U12, U23, U31 -	U12, U23, U31 V1, V2, V3	- V1
Source presence (source available)	✓	✓	✓	✓	✓	✓
Source in ranges (U, V, F)	✓	✓	✓	✓	✓	✓
Rotation phase order	-	-	-	✓	✓	S1 only
Neutral position	-	-	✓	-	✓	S1 only
Voltage unbalanced is lower than threshold	-	-	-	✓	✓	S1 only
METERING APPLICABLE TO ATYS C65 ONLY						
If CT connected (load side)	- - PT, QT, ST, PFT	- - PT, QT, ST, PFT	P1, Q1, S1, PF1 P2, Q2, S2, PF2 - PT, QT, ST, PFT I1, I2	P1, Q1, S1, PF1 P2, Q2, S2, PF2 P3, Q3, S3, PF3 PT, QT, ST, PFT I1, I2, I3, In	P1, Q1, S1, PF1 P2, Q2, S2, PF2 P3, Q3, S3, PF3 PT, QT, ST, PFT I1, I2, I3, In	P1, Q1, S1, PF1* P2, Q2, S2, PF2 P3, Q3, S3, PF3 PT, QT, ST, PFT I1, I2, I3, In

## 14.1.2. LOAD parameters menu (only C65)

The ability to measure and show the values on screen can be enabled or disabled on the first parameter "LOAD STATUS".

The values to configure are:

- LOAD TYPE: selection of the number of wires and current transformers used to measure.
- The number of Current Transformers (CT) that can be used to measure the current on the load side depends on the Network configuration:

NETWORK TYPE	LOAD TYPE	POSITION OF CT'S	NOTES
1P+N	1P+N_1 CT	On L1	Standard solution. Calculated neutral.
2P	2P_1 CT	On L1	Standard solution.
2P+N	2P+N_2 CT	On L1 and L2	Standard solution. Calculated neutral.
3P	3P_3 CT	On L1, L2 and L3	Standard solution.
	3P_2 CT	On L1 and L2	Accuracy reduced by 0.5%. Calculated L3.
	3P_1 CT	On L1	Only for balanced loads
3P+N	3P+N 4 CT	On L1, L2, L3 and N	Maximum accuracy. Measured Neutral.
	3P+N 3 CT	On L1, L2 and L3	Standard solution. Calculated neutral.
	3P+N 1 CT	On L1	Only for balanced loads.
3P+HL	User choice	User choice	Standard solution.
3P+N/1P+N	3P+N 4 CT	On L1, L2, L3 and N	Maximum accuracy. Measured Neutral.
	3P+N 3 CT	On L1, L2 and L3	Standard solution. Calculated neutral.
	3P+N 1 CT	On L1	Only for 1ph loads (from S2).

- Inom: nominal current for the loads
- LOAD NAME: name of the load group of the transfer switch (for example to be used on the webserver)
- CT PRIMARY and SECONDARY: transformation ratio of the current transformers. For the secondary the options are either 5A or 1A.
- NEUTRAL CT PRIMARY and SECONDARY: As the neutral current transformer can have different sizing, it can be selected independently. The secondary has to be either 5A or 1A.
- LINE I1,I2,I3,I4 WAY: sets the direction of the current transformer. For example, if the current transformers have been installed in the opposite direction, with this function it can be inverted by software, avoiding to physically turning the transformers

### 14.1.3. DISPLAY parameters menu

The PARAMETERS / DISPLAY menu allows to set the main parameters for the HMI.

#### 14.1.3.1. SCREEN PARAMETERS

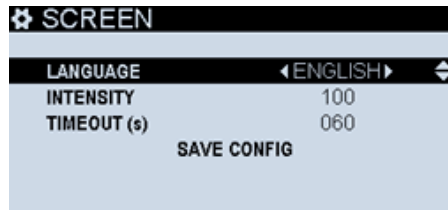

Languages available:

- English
- French
- Spanish
- Italian
- Chinese
- Turkish
- Portuguese
- German
- Polish

“Timeout” sets the time in seconds where the screen will remain on after touching a button.

#### 14.1.3.2. DATE AND TIME

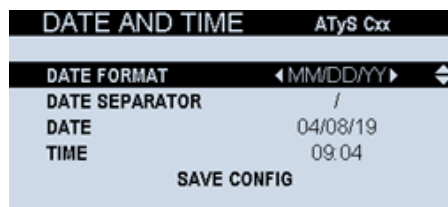

Date and time will remain running thanks to the RTC battery even if all sources are off.

### 14.1.3.3. LED CONFIG

This menu allows users to configure the X and Y LED (left side of the HMI) functioning mode, this is only available on the C65. For C55 these LED are fixed to the functions COM (LED active when switch is communicating) and Inhibit (LED is active when inhibit, partial inhibit or total inhibit is activated).

LED CONFIG		ATyS Cxx
X LED FUNCTION	◀COM▶	↕
X LED COLOR	BLUE	
X LED BEHAVIOR	STABLE ON	
X LED REPORT TYPE	NONE	
X LED REPORT IDX	NOT USED	
...		

- The X and Y LEDs on the front face can be used for several purposes. For each one of them there are different parameters that can be set:
  - FUNCTION: There are several functions that can be chosen:
    - ALWAYS ON: LED permanently on.
    - BUTTON RESPONSE: everytime a button is pressed it will become active (blink only).
    - COM: communication report (active when communicating through RS485)
    - SCHEDULER/EXERCISER ACTIVE: ON while the Engine Exerciser / Genset Scheduler is active (any of the programs)
    - INPUT REPORT: On when the selected input is active
    - OUTPUT REPORT: On when the selected output is active
    - NOT IN AUTO: On when the product is not in automatic mode (manual, inhibited, fault...)
    - INHIBIT MODE: On when the controller has been inhibited
    - LOAD SHED ACTIVE: On when load shedding (forced or smart) active
    - GENSET COOLDOWN: On while cooldown timer is running (genset is cooling down before being turned off)
    - LOAD CTRL: LOAD CONTROL output signal is active.
    - TRANSF ONGOING: Transfer is taking place (it counts from detection/request of transfer to transfer finalized, position reached)
    - MAINTEN. ALARM: LED will be active when a maintenance alarm is ongoing.
    - SERVICE: LED will be active when servicing is needed on the ATS system (based on the configured time between inspection)
    - None: LED not used
  - COLOR: Blue or Yellow.
  - BEHAVIOUR: Stable on (fixed) or blinking.
  - REPORT TYPE: (only for FUNCTIONS Input Report or Output Report) will allow choosing between internal I/O or external I/O modules (if any are connected).
  - REPORT IDX: Selects the input or output number to report.
- OPTIONS for the HMI buttons
- TEST button use (between ON LOAD or OFF LOAD test)
  - LAMP TEST duration (s): This will allow the user to change the duration of the lamp test button  available on the HMI. The lamp test will start after the button is pressed and the user can end the lamp test at any time by pressing the button again before this time limit.
  - POPUP DISPLAY : Users can select which pop-up windows to show, default and recommended value is "DISPLAY ALL" which will show all pop-up indications. Other options are "HIDE ALARM" (will hide alarm pop-ups but will show timers), "HIDE TIMER" (will hide timers but show alarms), "HIDE ALARM & TIMER (will hide both alarm and timer pop-ups).
- CHANGE PRODUCT NAME: allows changing the name of the ATS. This information will appear on all the dashboards and menus on the top-right of the screen.
- SCREENSAVER TEXT: User can replace the default Socomec logo on the home screen by 4 lines of personalized text. There are multiple options for size and police. before saving the configuration it is possible to preview the results.

## 14.1.4. TIMERS parameters menu

All the operational timers can be set on this menu. They are up to 26 general timers splitted into 4 groups:

 Note: the timers linked to specific functions are not included in this chapter. Consult the Timers Annex in chapter "Annex 16 - 2. Timers list", page 88 to have the full list.

### 14.1.4.1. Operation timers

OPERATION	ATyS Cxx
S1 FAILURE (s)	03.0
S1 RETURN (s)	0003
S2 FAILURE (s)	03.0
S2 AVAILABLE (s)	0005
SAVE CONFIG	

- FAILURE TIMER (s): time after source is lost, to make sure it's really lost and start a transfer.
- RETURN TIMER (s): time after a transformer/main source that was off comes back, to make sure it really came back.
- AVAILABLE TIMER (s): time for a genset/diesel generator source to be on and inside the right defined values to be considered available and ready to accept a transfer.
- S1 DEAD BAND (s): time to wait without load supply (including source failure time and time in center-off / zero position) when transferring from S1 to S2.
- S2 DEAD BAND (s): time to wait without load supply (including source failure time and time in center-off / zero position) when transferring from S2 to S1.

 Note: by default, S1 and S2 DEAD BAND are the same and set to 3s. On C55 there is no differentiation between S1 or S2. For ATyS FT technology (I-II switch, with no 0 position), DBT timer does not exist.

 Note: see "Annex 16 - 5. Operating sequences", page 96 for operational timer graph and see TIMER Annex for more details on configurable values for these timers

### 14.1.4.2. Genset source 1/2 timers

 Note: if the source is not linked to a genset the following message will be shown:

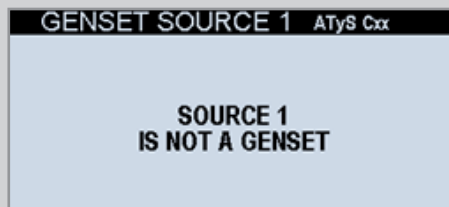

- Genset source 1 and source 2 are available if the source is related to a genset (in M/G depending on priority, and in G/G).

GENSET SOURCE 2	ATyS
S2 GENSET COOLDOWN (s)	180
S2 START TIMEOUT (s)	030
GENSET TIMEOUT S2 (h)	001
BATT CHARGE DURATION S2 (s)	0050
SAVE CONFIG	

- GENSET COOLDOWN (s): This timer will count down once the load leaves the source with a genset, when this timer expires the genset start signal linked to this source will be deactivated. This timer is used to cool-down the genset before shutting it down.
- START TIMEOUT (s): Maximum time for the genset to start. After this time, a fault will pop-up saying "Fail to start genset".

 This timer must be greater than the source "AVAILABLE TIMER" or the genset will always be considered as fail to start.



 Note: GENSET TIMEOUT (h) and BATT CHARGE DURATION are both linked the the output "BATTERY CHARGER".

- GENSET TIMEOUT (h): The purpose of this timer is to make sure that if the generator is turned off for long period of time the generator internal battery is not depleted. This timer will start when the genset is off, when this timer ends the BATTERY CHARGER output will be activated, this output can be linked to a battery charger. This timer will reset if the genset is on for the duration of BATT CHARGE DURATION, or if the output "BATTERY CHARGER" is activated for the duration of BATT CHARGE DURATION.
- BATT CHARGE DURATION (s): This timer represents the time needed to fully charge the generator battery. The timer will count down when the "BATTERY CHARGER" output is active or when the genset is available. The end of this timer will reset the GENSET TIMEOUT TIMER.

 In GEN-GEN The "GENSET TIMEOUT" and "BATT CHARGE DURATION" timers as well as the "BATTERY CHARGER" output will apply only to the secondary genset.

### 14.1.4.3. Test on/off load timers

- Tests on load (5 timers) and off load (4 timers)

- TEST ON/OFF LOAD (limited or unlimited) Limited means there is a defined test time and it will perform the changeover and the comeback to the priority source automatically after the configured time has elapsed. Unlimited will require action (TEST push button, HMI, programmable input or communication) from the user to come back to the priority source. In unlimited, if the user does not manually cancel the tests the controller will stay in secondary source unless the secondary source is lost and priority one is available, in that case it will transfer to the available source and end the test automatically (except if the option TEST PRIO has been selected on the NETWORK/APPLICATION menu).

LOAD TESTS		ATyS Cxx
LOAD TEST	◀ UNLIMITED ▶	⬇
LOAD TEST (s)	00010	
LOAD TEST END (s)	0005	
EXT LOAD TEST PRE (s)	0005	
EXT LOAD TEST	UNLIMITED	
...		

NO LOAD TESTS		ATyS Cxx
NO LOAD TEST	◀ UNLIMITED ▶	⬇
NO LOAD TEST (s)	00600	
EXT NO LOAD TEST PRE (s)	0005	
EXT NO LOAD TEST	LIMITED	
EXT NO LOAD TEST (s)	00600	
...		

- (EXT) TEST ON/OFF LOAD (s): duration of the test
- TEST ON LOAD END (s): after a test on load (not external), time to wait in secondary source before going back to priority source
- EXT TEST ON/OFF LOAD : Similarly to the parameter in TEST ON/OFF LOAD, this defines if the type of test (limited or unlimited) when starting and external load test (load test activated using "EXT LOAD" or "EXT NO LOAD" inputs or communication)
- EXT. TEST ON/OFF LOAD PRE (s): pre-timer before starting transfer to secondary source on an external test.
- EXT. TEST ON/OFF LOAD POST (s): post-timer after finishing the test and going back to priority source on an external test.

 Note: see "Annex 16 - 5. Operating sequences", page 96 for operational timer graph and see TIMER Annex for more details on configurable values for these timers

### 14.1.5. I/O parameters menu

All the I/O can be set on this menu. By default, the controller has 6 inputs and 6 outputs on the controller (called internal Inputs / Outputs) and up to 6 optional I/O 10 modules with 4in/2out can be added (only C65) achieving up to 30 inputs and 18 outputs total. The I/O menu has the following submenus:

- INPUTS: permits configuring the 6 internal inputs

INPUTS ATyS Cxx	
INPUT1	◀ SWITCH IN POS. 1 ▶
INPUT2	SWITCH IN POS. 2
INPUT3	NONE
INPUT4	NONE
INPUT5	EXT. LOAD
...	

- OUTPUTS: permits configuring the 6 internal outputs

OUTPUTS ATyS Cxx	
OUTPUT1	◀ POS 1 ORDER ▶
OUTPUT2	POS 2 ORDER
OUTPUT3	NONE
OUTPUT4	FORCED SHEDDING
OUTPUT5	ELEVATOR
...	

- EXTERNAL I/O DETECTION: permits detecting and autoconfiguring the external I/O modules. A Pop-up will signal the start and end of the IO module detection, this detection can take a few minutes to complete.

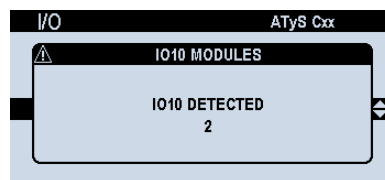
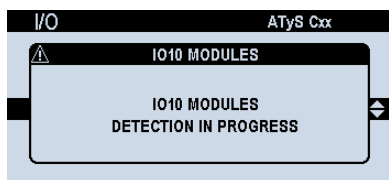

- EXTERNAL I/O CONFIG: permits configuring each one of the external modules. The way to identify the modules is thanks to the module ID, written on the module and unique for each one of them. The configuration procedure is the same than with the internal I/Os

EXT I/O CONFIG ATyS Cxx	
IO10 MODULE 1 ID:	76891A
IO10 MODULE 2 ID:	4AC29B
IO10 MODULE 3 ID:	C8B3DB
IO10 MODULE 4 ID:	FACB2C

IO10 MODULE 1 ATyS Cxx	
INPUT1	◀ NONE ▶
INPUT2	NONE
INPUT3	NONE
INPUT4	NONE
INPUT 1 TYPE	NO
...	

 Note: the specific functions that are related to the I/O might require some settings to be configured on the SPECIFIC FUNCTIONS menu. Consult the I/O Annex 15 - 3, page 91 and Annex 15 - 4, page 94 to have the full list of functions to be configured on the I/O.

 Warning after each menu configuration do not forget to save by pressing "SAVE CONFIG" or pressing the "OK" button for at least 1.5 seconds.

## 14.1.6. COMMUNICATION parameters menu

### 14.1.6.1. RS485

The MODBUS RTU protocol available on the ATyS C55/C65 communicates via an RS485 series link (2 or 3 wires) which is used to operate, configure or read parameters from a PC or an API.

In a standard configuration, a RS485 connection is used to connect 32 products to a PC or a controller up to 1200metres (1300yds) far.

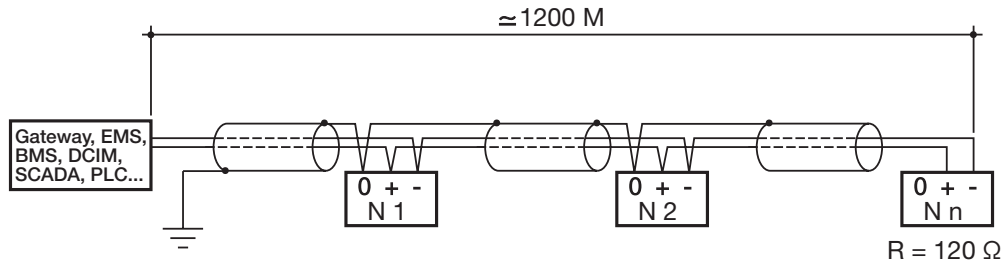

A LIYCY shielded twisted pair must be used. Socomec recommends using a shielded twisted pair with a general LIYCY-CY shielding in a environment where there is interference or in a very long network with a number of products.

**If the distance of 1200 m is exceeded and/or the number of products is greater than 32, a repeater must be added to enable additional products to be connected.**

A 120 Ohm resistor must be fixed at both ends of the connection.

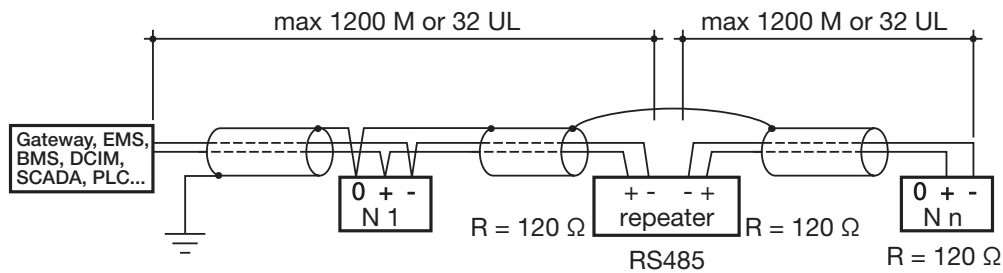

Communication tables: can be found on the website at the following address:

[www.socomec.com](http://www.socomec.com)

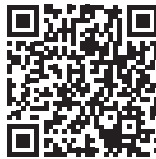

For C65 :

[https://www.socomec.com/files/live/sites/systemsite/files/SCP/2\\_commutateurs/atys-a15-cx5-c66/ATYS-C65-MODBUS\\_COMMUNICATION-TABLE\\_2019-11\\_CMT1.1.3\\_MULTI.pdf](https://www.socomec.com/files/live/sites/systemsite/files/SCP/2_commutateurs/atys-a15-cx5-c66/ATYS-C65-MODBUS_COMMUNICATION-TABLE_2019-11_CMT1.1.3_MULTI.pdf)

For C55:

[https://www.socomec.com/files/live/sites/systemsite/files/SCP/2\\_commutateurs/atys-a15-cx5-c66/ATYS-C55-MODBUS\\_COMMUNICATION-TABLE\\_2019-11\\_CMT1.1.3\\_MULTI.pdf](https://www.socomec.com/files/live/sites/systemsite/files/SCP/2_commutateurs/atys-a15-cx5-c66/ATYS-C55-MODBUS_COMMUNICATION-TABLE_2019-11_CMT1.1.3_MULTI.pdf)

### 14.1.6.2. Communications Menu

The ATyS C55 and C65 have RS485 communication by default using MODBUS RTU protocol. Inside the communication menu the main parameters to make that communication effective can be set.

- MODBUS ADDRESS: By default 6, any value between 1 and 247 can be used.

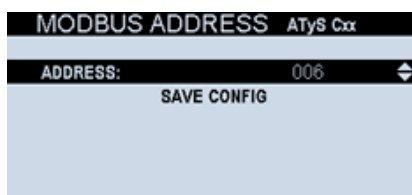

- RS485 MODBUS: All Modbus parameters can be set here:

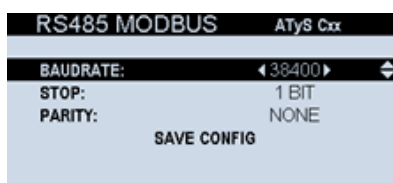

- BAUDRATE (1200-2400-4800-9600-19200-38400-57600-115200) By default 38400.
- STOP: (1BIT – 2BITS) By default 1 BIT
- PARITY: (ODD-EVEN-NONE) By default none

- DIGIBUS COMM: The same parameters than for RS485 can be set also for the Digibus connection (RJ45 inputs on ATyS C65) when integrated in a DIRIS Digiware system.

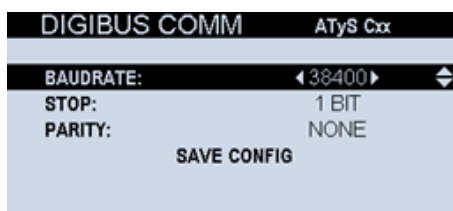

- DIGIWARE MODE: to be able to use the controller inside a Digiware chain, it's needed to change the parameter MODE to SLAVE. To be able to use external I/O modules the function of the RJ45 has to be switched to "MASTER OVER I/O" changing the MODE parameter:



### 14.1.6.3. Digiware

The product offers the option to choose between controlling external I/O modules through the RJ45 connectors (master) with the Digiware bus or to be integrated into a complete Digiware system as a slave.

Control over I/O modules as a Digiware master.

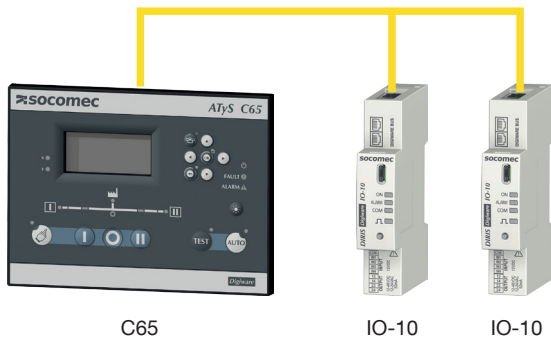

Controller as a slave, part of a Digiware chain, working as a U10 module that sends the voltage sensing information into the chain to be read by other measurement modules.

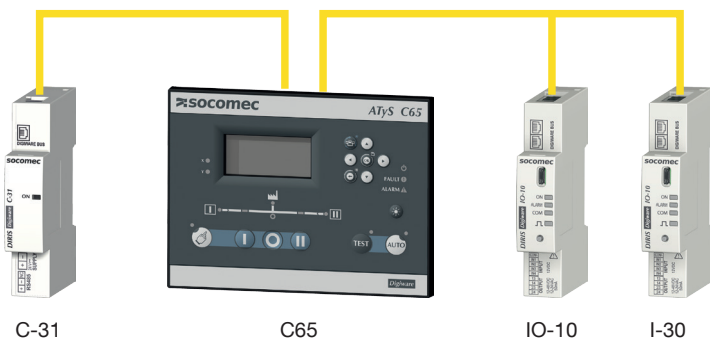

These two options can be selected on the menu, to change between slave and master, go to "PARAMETERS">"COMMUNICATION">"DIGIWARE MODE".



Note: it's not possible to be at the same time master over I/O and slave in the Digiware chain.



In slave mode the controller will not configure or control the I/O modules

### 14.1.6.4. Ethernet

For the ATyS C55/65 controller to be able to communicate on MODBUS TCP over Ethernet, it's necessary to add a gateway to convert from RS485 to RJ45 and use TCP protocol:

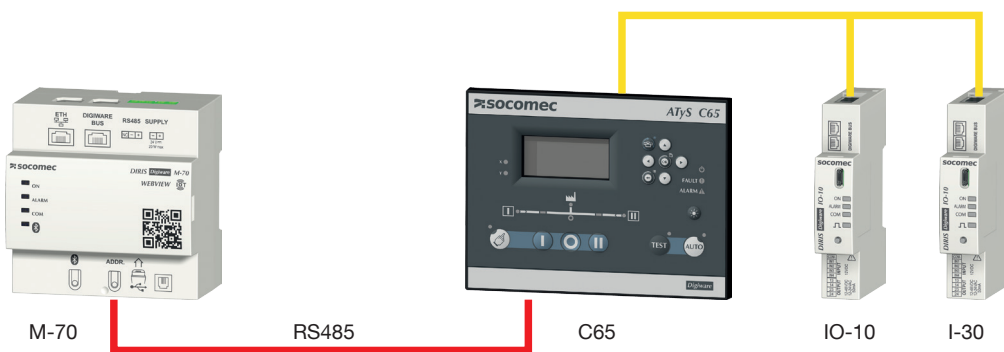

When the D70 or M70 Socomec gateways are used, the ATyS CXX can be connected by RS485 or with the Digiware.

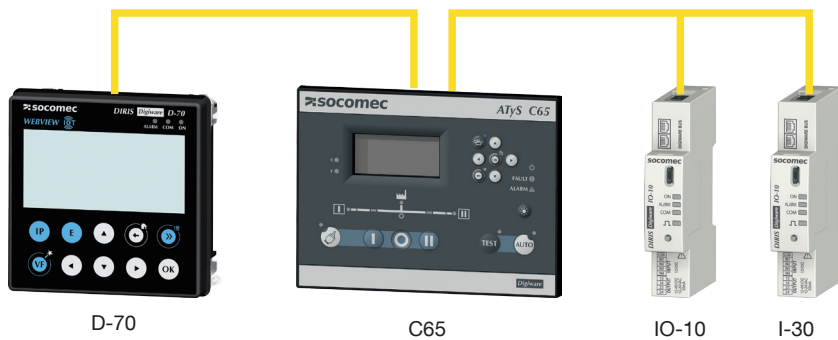

Using Diris D70 gateway.

**Note:** when the controller is part of a Digiware chain, it's not possible to use the external I/O modules in direct connection with the controller.

### 14.1.6.5. I/O module connections

#### Digital Inputs / Outputs

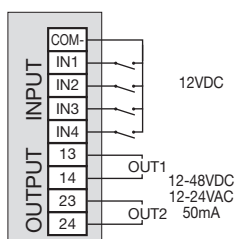

#### Digiware Bus



Total power consumption per module is 0,5W and each 50mts (164 feet) of RJ45 cable 1,5W extra should be considered for the design of the installation.

For more technical details on the Digital I/O modules consult the I/O module Quickstart.

#### I/O module connection cables:

RJ 45 Digiware bus cables available can be ordered according to their length:

LONGUEUR (M)	QUANTITÉ	RÉFÉRENCE
0.1	1	4829 0181
0.2	1	4829 0188
0.5	1	4829 0182
1	1	4829 0183
2	1	4829 0184
5	1	4829 0186
10	1	4829 0187
50 m reel + 100 connectors		4829 0185

**Note:** these cables are specific RJ45 cable for use with the DIGIWARE bus, do not use standard RJ45 cables. The maximum length of the Digiware bus is 100 meters (328 feet).

A end-of-the-bus resistance is recommended for safe communication between the modules and the controller:

	QUANTITY	PART NUMBER
	1	4829 0180

Configuration of the modules:

Once the controller is powered up with the 24 V.d.c auxiliary power connected, the modules will receive power supply. To configure these modules follow the steps below:

1. Configuring the controller as master on DIGIWARE Bus:

"PARAMETERS">"COMMUNICATION">"DIGIWARE MODE" change the type from "SLAVE" to "MASTER OVER I/O"

2. Detecting the I/O modules:

In "PARAMETER">"I/O">"EXTERNAL I/O DETECTION" press OK on "EXTERNAL I/O DETECTION" the detection process will take a few minutes, when the detection is over a message will indicate that the detection is over. The devices will be detected and added to the list

3. Configuring the I/O module's I/Os:

In "PARAMETERS">"I/O">"EXTERNAL I/O CONFIG" user can affect Input and output functions on the I/O module, for full list of available functions see Annex 16.3 Input list & 16.4 output list.

To identify the different modules the "ID" number on the front face of the modules will be shown on the display.

### 14.1.7. ALARMS parameters menu

The ALARMS are different from the FAULTS on the ATS Controller. The Alarms are user configurable while the faults are internal to the product and cannot be disabled. Everything that is critical for the application is set as Fault (chapter 12, maintenance, to know more about Faults).

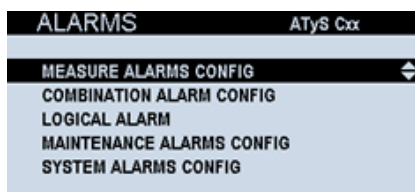

All alarms are set by default to "DISABLED" (except some system alarms) to activate the alarms user must switch them to "ENABLED". Each alarm has independent settings for : threshold, acknowledgment method, output type, output report and criticality.

**Thresholds (only for Measure and Maintenance alarms):** this is the value that will trigger the alarm. For example, the inspection time, it will be the time since the last inspection (set on Inspection Mode) and for the other types it will be the number of operations/cycles or a time value in seconds.

**Acknowledgment method:** Acknowledging an alarm will reset the alarm LED and remove the alarm from the active alarm list until it is activated again, an alarm should be acknowledged when the user has understood and taken specific action according to the alarm triggered. Changing the acknowledgment method will allow the user to acknowledge either through : display, communication, or using the inputs.

**Output type:** the alarms can be associated to an output that will become active while the alarm is active too. The output used can be chosen between the internal and the external outputs (extension modules).

**Criticality:** a level can be chosen for each alarm between INFORMATION, WARNING and CRITICAL, this last setting represents the highest level of criticality. This information will be registered in the alarm log and can be consulted with the webserver function on the Diris M-70 gateway module.



Note: if using the "AUD – Audible alarm" output, it will only be active with the alarms set as CRITICAL.

There are different types of alarms on ATyS Cxx:

### MEASURE ALARMS CONFIG – (Only on C65)

MEASURE ALARMS ATyS Cxx	
ALARM ID	◀ 1 ▶
STATUS	DISABLED
CATEGORY	E LOAD
SOURCES	LOAD
PARAMETERS	Partial Ea+
...	

- CATEGORY: which value will trigger the alarm.

- Energy (consumption) from a source
- Energy (consumption) from the load side (total)
- V/U/F from a source
- V/U/F from the load
- P/Q/S/PF
- I (current)

- PARAMETERS: inside each one of the categories there can be different options like:

- Energy (E LOAD or E SOURCES) Partial Ea+ (consumed active energy using partial counter), Partial Ea- (same but generated), Partial Es, Partial Er+, Partial Er-.
- V/U/F LOAD: Vsys (system avg phase to neutral voltage), F (frequency value), Uph OR (composed voltage phase-phase, counting any of the values), Uph AND (same but counting all 3 U values above limits U12 U23 and U31), U sys (composed voltage avg), Vph OR (same for phase to neutral voltages, counting any of the values V1 V2 V3), Vph AND (same but counting all of them), Vn (neutral voltage).
- V/U/F SOURCES: Vsys, Vunb (vectorial unbalance, based on phase and amplitude), F, Uph OR, Uph AND, Unba (absolute phase-phase unbalance, absolute amplitude value (no phase)), Usys, Uunb (vectorial unbalance on phase-phase voltages, based on phase and amplitude), Vph OR, Vph AND, Vn, Vnba (absolute unbalance, absolute amplitude value (no phase)).
- P/Q/S/PF: P OR (any of active power values), P AND (all active power values), Ptot (total active power), Q OR (any of reactive power values), Q AND (all reactive power values), Qtot (total reactive power), S OR (S1 or S2 or S3 out of limits), S AND (S1 and S2 and S3 out of limits), Stot (total apparent power), PF OR (any of power factor values), PF AND (all of power factor values), PFtot (total power factor), PF TYPE OR (PF1 or PF2 or PF3 leading/lagging (non desired value is settable)), PF TYPE AND (PF1 and PF2 and PF3 leading/lagging (non desired value is settable)), PF TYPE TOT(PF tot average (not the desired type, leading or lagging)).
- I (current): Isys (system current), Iunb (current unbalanced, taking into account vector and absolute value), In (neutral current), Iph OR (any phase current), Iph AND (all phase currents), Inba (absolute, non-vector current value).



**MAINTENANCE ALARMS CONFIG** – Allows the service (maintenance password required) to set up to 6 alarms of different or the same type.

The alarms configured in this menu will be visible on the maintenance dashboard.

The alarm ID will be shown in the product logs if this alarm is activated, to activate the alarm first change "STATUS" to "ENABLED", user will then have access to other configuration parameters.

Possible alarm configuration:

ALARM TYPE	ALARM NAME	DESCRIPTION	THRESHOLD UNIT	"THRESHHOLD DEFAULT VALUE"	"UPPER THRESHOLD MAX. VALUE"
1	CYCLE EXC.	"Maximum number of switching cycles. A cycle is when the switch has reached the opposite source and transferred back once (for example 1-off, off-2, 2-off, off-1)"	number of cycles	5000	10 000
2	OPERATION EXC.	Maximum number of operation (any change of position order including off position)	number of operations	10 000	10 000
3	GENSET RUNTIME S1	"Total amount of time that the genset 1 has been working (supplying or not the load). Can be used for genset maintenance purposes."	hours	250	400 000
4	GENSET RUNTIME S2	"Total amount of time that the genset 2 has been working (supplying or not the load). Can be used for genset maintenance purposes."	hours	250	400 000
5	TOT GS1 TIME ON LOAD	Total amount of time that the genset 1 has been connected to the load. Can be used for genset maintenance purposes.	hours	250	400 000
6	TOT GS2 TIME ON LOAD	Total amount of time that the genset 2 has been connected to the load. Can be used for genset maintenance purposes.	hours	250	400 000
7	INSPECTION	"Counts the time after the last inspection (entered in "Inspection Mode" of the maintenance menu). Can be used for periodic inspection/service purposes on the A TS. By default it is set to 300 months which is the maximum value. Socomec recommends 12 months after servicing."	Months	300	300
8	CONNECTED	Maximum number of time the input CONNECTED has been switched on	action	3	10 000
9	WITHDRAWN	Maximum number of time the input WITHDRAWN has been switched on	action	3	10 000
10	TOTAL TRIP BRK1	Maximum of time the input TRIP BRK1 has been switched on	action	3	10 000
11	TOTAL TRIP BRK2	Maximum of time the input TRIP BRK2 has been switched on	action	3	10 000

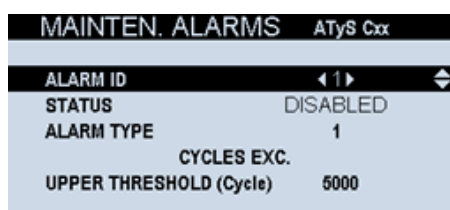

**COMBINATION ALARMS CONFIG** – (Only on C65) Permits up to 4 boolean combination alarms (using OR / AND) on the defined alarms (logical, measurement, maintenance). This can be done by using the INDEX of each one of the 2 alarms to combine.

COMBI ALARMS		ATyS Cxx
ALARM ID	◀ 1 ▶	
STATUS	DISABLED	
CRITICITY	INFORMATION	
LOGIC	AND	
ALARM 1 TYPE	ANALOG	
...		

**LOGICAL ALARMS CONFIG** – Permits up to 4 alarms using the internal or external inputs.

LOGICAL ALARMS		ATyS Cxx
ALARM ID	◀ 1 ▶	
STATUS	DISABLED	
ACK METHOD	NONE	
INPUT TYPE	NONE	
ACK INPUT	NOT USED	
...		

**SYSTEM ALARMS CONFIG** – There are up to 8 system alarms that can be used to detect minor failures on the installation.

SYSTEM ALARMS		ATyS Cxx
ALARM TYPE	◀ 1 ▶	
	PHASE ROTATION ERROR	
STATUS	ENABLED	
ACK METHOD	NONE	
INPUT TYPE	NONE	
...		

- Phase rotation error: If a change on phase rotation occurs, alarm will be activated.
- External alarm: If an input is configured as External Alarm, this alarm will be activated when the input will be active.
- I/O connection failed: If a configured external I/O module suddenly is not detected, this alarm will be active in order to alert the user that a cable might accidentally been disconnected (Only on C65).
- Controller unavailable: If the controller loses the ability to perform the transfer functions this alarm will be activated (major fault or product inhibited).
- Load not supplied: If load is not supplied by any cause, this alarm can be activated if enabled.
- RTC Low battery: If the RTC battery has low battery and needs to be changed, this alarm will be active.
- DC AUX supply out of limits: If the DC auxiliary supply is out of limits (less than 10 VDC) this alarm will become active.
- GENSET RUNNING, will activate if the source(s) with generators are still available 10 seconds after the startgen signal has been removed (after cooldown timer has expired).

## 14.1.8. PASSWORDS

The controller considers there are 4 levels of user who can use it, so it uses 4 level of security:

- Standard user – it requires no password and it permits the visualization of the parameters and values measured by the controller through the dashboards. It is the level by default and if another user stays away from the controller for more than 5 minutes with no actions, the security level will become Standard user automatically.
- Operator - it requires the Operator password (by default 4000, can be changed in the Configurator level inside Parameters). It allows changing the operating mode, sending position orders to the switch and setting the engine exerciser parameters and alarms.
- Configurator – it requires the Configurator password (by default 1000, can be changed). It allows to change any configuration of the controller (operating range, timers, type of control, display settings, etc)
- Maintenance – It's the highest level of security. It requires the maintenance password (by default 1010) and it permits resetting counters, rebooting the device, changing and restoring passwords of other users and entering inspection date and telephone number.

Passwords by default (factory settings):

User (access to visualization )	No password
Operator (access to control functions)	4000
Configurator (access to parameter setting)	1000
Maintenance (access to service menu)	1010

These default passwords can be changed in the Parameters / Passwords menu (Configurator or Maintenance access).

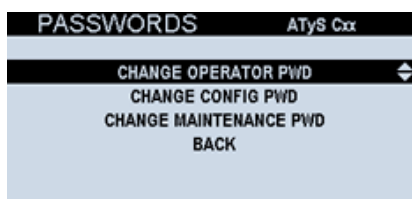

 **WARNING !** If the maintenance password is lost it cannot be restored. Please contact SOCOMEC in case this operation is needed.

## 14.2. Specific Functions Menu

The controller integrates some specific functions that can be configured in this menu:

### 14.2.1. Manual retransfer

If this function is active (“YES”), when loads are supplied from the emergency source, the controller will not come back to the normal source when this one comes back until a confirmation order is received through the display or through an input (configured to do so). This applies also to TEST ON LOAD requests, a manual retransfer will be required to go back to the priority source.

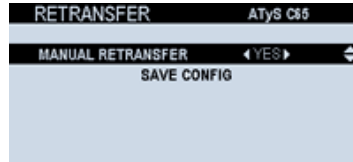

Every time the Manual Retransfer is requested, a pop-up will appear on the screen allowing the user to act immediately or it can be dismissed and done any other time by using the menu CONTROL/MANUAL RETRANS:

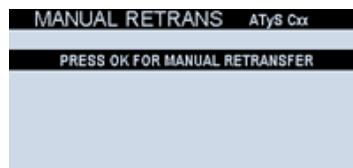

If the dashboard key is pressed on the keypad while manual retransfer is needed, there will be a bottom message line on screens 1.2 and 2.1 reminding the user that the retransfer approval is required.

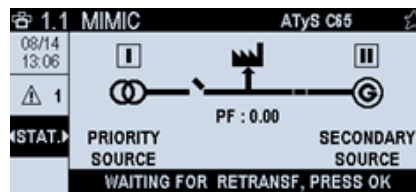

### 14.2.2. In-phase transfer (C65 only)

The in-phase transfer is available for ATyS FT typology of RTSE or equivalent (2 position switch Class PC, I-II). It allows the phase monitoring of the 2 sources, checking the Voltage, Frequency and Phase Angle continuously to make sure that the sources are within the set synchronized window when performing the transfer from one source to the other.

All settings for the in-phase monitoring transition with the ATyS FT switch:

- Voltage range (0.5 - 20% of nominal voltage, default 2%)
- Frequency range (0.1-0.5Hz, default 0.2Hz)
- Angle (1-30°, default 7°)
- Dwell time / In phase time (time necessary to be in the correct synchro window to authorize transfer) (0-5000ms, default 500ms)
- In-phase research delay / Fail To Sync timer (0-1200s, default 180s)
- Fail to sync option, to decide what to do when the research timer is over. USER CHOICE (pop-up is offered to decide to transfer anyway or continue searching) or FORCE TRANSFER (transfer is performed at the end of research delay independently from the synchronism of sources)

At any time, the synchronism status of the 2 sources can be checked on the dashboard 2.2 STATUS / SYNC:

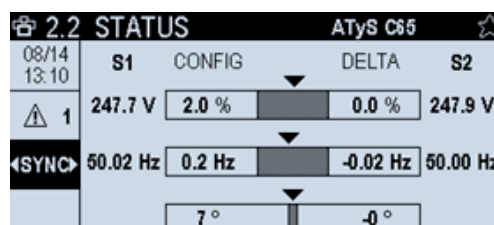

**i** Note: in-phase transfer is only available for I-II switches, selected technology must be ATyS FT, this function cannot be enabled when using other technology.

### 14.2.3. Return to 0

This function allows the switch to go to center-off position (only typologies with 0 or center-off position) when the current connected source is lost or not available (supply to the load is not good enough due to undervoltage, phase lost, overvoltage, frequency out of limits,...). It can be used to avoid providing bad quality energy to the loads but also to avoid the power ramp and transients that may occur before the source is stable to go to the loads, as some loads might be sensitive to these events.

RETURN TO 0		ATyS Cxx
RETURN TO 0		◀ FROM PRIO SOURCE ▶
S1 RETURN TO 0 (s)		09
S2 RETURN TO 0 (s)		10
SAVE CONFIG		

Associated timer to configure:

- RETURN TO 0 : Status of the function, user can choose when to activate the function DISABLED / ALWAYS ENABLED / FROM PRIORITY SOURCE / FROM SECONDARY SOURCE
- S1 / S2 RETURN TO 0 (s): time to wait before going to center-off / zero position after losing a source. (starts counting at same time than the failure timer)

**i** Note: this function will only work if both the switch and the controller are still supplied (by an external source, UPS or others, independent from the emergency and normal source).

If the typology of the switch (technology) doesn't allow the function, a message will pop up as follows:

RETURN TO 0		ATyS C65
NOT AVAILABLE IN ATyS FT		

### 14.2.4. Load control (C65 only)

The load control signal is used to communicate to the elevator control panel in buildings, or other loads, that the controller is ready to perform a transfer.

The function has 2 main parameters to be set on the function menu, the pre-transfer timer (time before sending the order to transfer to the switch, when the load control output will become active) and the post-transfer timer (time after achieving the transfer to the other source, when the load control will be cleared, not active).

To be able to use the load control signal function, it is required to configure an output as ELV – LOAD CTRL output in the PARAMETERS / I/O / I/O CONFIG menu.

LOAD CTRL		ATyS Cxx
STATUS		◀ DISABLED ▶
PRE TRANSFER TIMER (s)		0010
POST TRANSFER TIMER (s)		0015
SAVE CONFIG		

### 14.2.5. Load shedding (C65 only)

ATyS C65 counts with 2 types of load shedding features:

- **Forced load shedding:** This type of load shedding will activate the LSC - Load Shedding Contact / Forced Shedding output every time there is a transfer to the secondary source. The forced load shedding is used in cases where the load power is stable and the secondary source provides less power than the normal/main source. The values to configure for this function are the pre-transfer and post-transfer timers (by default, 4 and 1s respectively).

LOAD SHEDDING		ATyS Cxx
STATUS	◀ ENABLED ▶	
PRE TRANSFER TIMER (s)	10	
POST TRANSFER TIMER (s)	05	
SAVE CONFIG		

- **Smart load shedding:** A kVA limit can be set and when this limit is exceeded the controller can perform an automatic load shedding in the same way than in the forced load shedding by activating an output (has to be configured as PTS - Power Threshold Exceeded / Smart Shedding) that will go to the switching device opening the circuit for the non-essential loads of the installation. The threshold and hysteresis defined will define the activation/deactivation of this output. The main use of this function is the same as before with the difference that if the load required power is variable in some cases it might not be necessary to shed the loads when transferring to the secondary source and the controller will automatically detect the power level and decide if to shed loads or not intelligently.

LOAD SHEDDING		ATyS Cxx
S1 Auto load shed (kVA)	0000	
S2 Auto load shed (kVA)	0000	
S1 Auto load shed restore (kVA)	0000	
S2 Auto load shed restore (kVA)	0000	
SAVE CONFIG		

 Note: for Smart load shedding it is necessary to use current transformers with the product. See chapter "9.3. Dual Power Supply / Sensing", page 22.

### 14.2.6. Power up in auto

Enabling "power up in auto" will force the controller to start in automatic mode every time the controller recovers power (even if mode before the power failed was manual). Set to "DISABLED" as standard.

### 14.2.7. DBT Timer in CTRL (C65 only)

In CONTROL mode (manually operating the switch through the controller buttons or via communications), this function will force the controller to take into account the "dead band timer" when transferring from one source to the other.

### 14.2.8. HVAC compressor (C65 only)

This is a specific function designed to preserve the lifetime of the compressors inside HVAC units. When going back to principal source position the contact will become active prior to starting the transfer (to shut down the compressor), then the transfer will take place and then after reaching the opposite source, a configurable timer will elapse before deactivating this output again. It avoids stressing the compressors in HVAC chillers.

## 14.2.9. Tripping actions

This specific function allows user to configure how the controller should react if one or either of the breakers used in the RTSE trips.



Note: for these functions to be functional 2 inputs must be configured to "TRIP BRK1" and "TRIP BRK2".

Settings in the menu are the following:

SETTING	OPTION	DESCRIPTION
SWITCH	BREAKER 1, BREAKER 2	Selects on which breaker the configuration applies
TRIP ACTION	TRIP = SOURCE LOST, PARTIAL INHIBITION, INHIBITION, TOTAL INHIBITION.	This setting defines the action to apply when the trip signal for the corresponding breaker is active. If "TRIP = SOURCE LOST" the controller will define the source is unavailable and will continue working automatically (will switch to the opposite source if this is the active source). In all other cases controller actions will be inhibited (cf input menu for more details on the types of inhibitions)
OP MODE AFTER TRIP	PREVIOUS MODE, AUTOMACTIC, PARTIAL INHIBITION, INHIBITION	This setting allows user to select which operating mode the controller will return to after the trip signal has been disabled (input has returned to inactive).
CHRG. TIME STATUS	DISABLED, WHEN OPEN, WHEN CLOSED	Allows users to configure a charging time for the breaker to give time to charge the spring mechanism before sending an order. Users can define if the spring is charged after a close order or open order. If a charging time has been configured the controller will wait the specified duration before sending another order. NB: each charging time will be overridden if an input giving the charging status of the breaker is configured.
CHARGING TIME(s)	0.00-15.00s	

TRIPPING ACTION		ATyS C65
SWITCH	◀ BREAKER 1 ▶	◄
TRIPPING ACTION	TOTAL INHIBITION	
OP MODE AFTER TRIP	INHIBITION	
CHRG. TIME STATUS	DISABLED	
CHARGING TIME (s)	00.0	
...		

When a tripping action is detected ("TRIP BRK1 or "TRIP BRK2" is active) the controller will inform the user with a pop-up, the information that the breaker is tripped, this information will also be visible on the main synoptic.

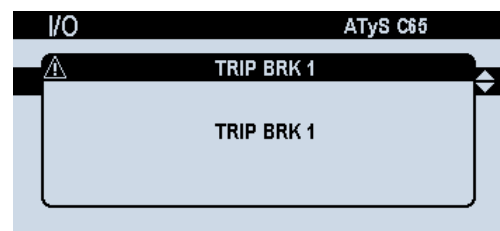
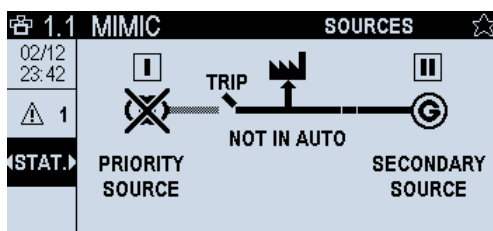

**WARNING !** A tripping action on either one of breakers will be seen as "UNEXPECTED TRANSFER" .To avoid having to reset the fault the trip action must be set to "TRIP = SOURCE LOST". In any case the controller will register a tripping action in the log history as "UNEXPECTED TRANSFER".

## 14.2.10. LOAD ADDING DELAY

The load adding delay function allows user to gradually add separate loads (up to 7 for C65, up to 3 for C55) when transferring between sources.

This function can be used to manage and control the inrush-current in the installation after a transfer by gradually adding loads.

These timers available in "SPECIFIC FUNCTION" > "LOAD ADDING" are linked to outputs "ON DELAY 1-7" (variable from 1 - 7 corresponding to timer number). To program these outputs go to "PARAMETERS" > "I/O" > "OUPUTS".

The settings in the menu are as follow:

- STATUS : to Select when the load adding function is applied, option are :
  - DISABLED (function not active)
  - TO SOURCE 2 (function will be active only when transferring to source 2)
  - TO SOURCE 1 (function will be active only when transferring to source 1)
  - ALWAYS ENABLED (function will be active in all cases of transfer)
- PRE TRANSFER TIMER (s): this allows user to configure the time for which all loads should be removed before the transfer. During this time all "ON DELAY" outputs will be active. This timer is only counted when transferring between two available sources; in case of loss of source, this timer will not be counted.



This timer will delay the transfer by the amount set.

- ON DELAY 1 TIMER (s) : Time for which the output "ON DELAY 1" is active after a transfer (default 20s, max 3600s)
- ON DELAY 2 TIMER (s) : Time for which the output "ON DELAY 2" is active after a transfer (default 40s, max 3600s)
- ON DELAY 3 TIMER (s) : Time for which the output "ON DELAY 3" is active after a transfer (default 60s, max 3600s)

LOAD ADDING		ATyS C65
STATUS	◀ TO SOURCE 1 ONLY ▶	
PRE TRANSFER TIMER (s)	10	
ON DELAY 1 TIMER (s)	0020	
ON DELAY 2 TIMER (s)	0040	
ON DELAY 3 TIMER (s)	0060	
...		

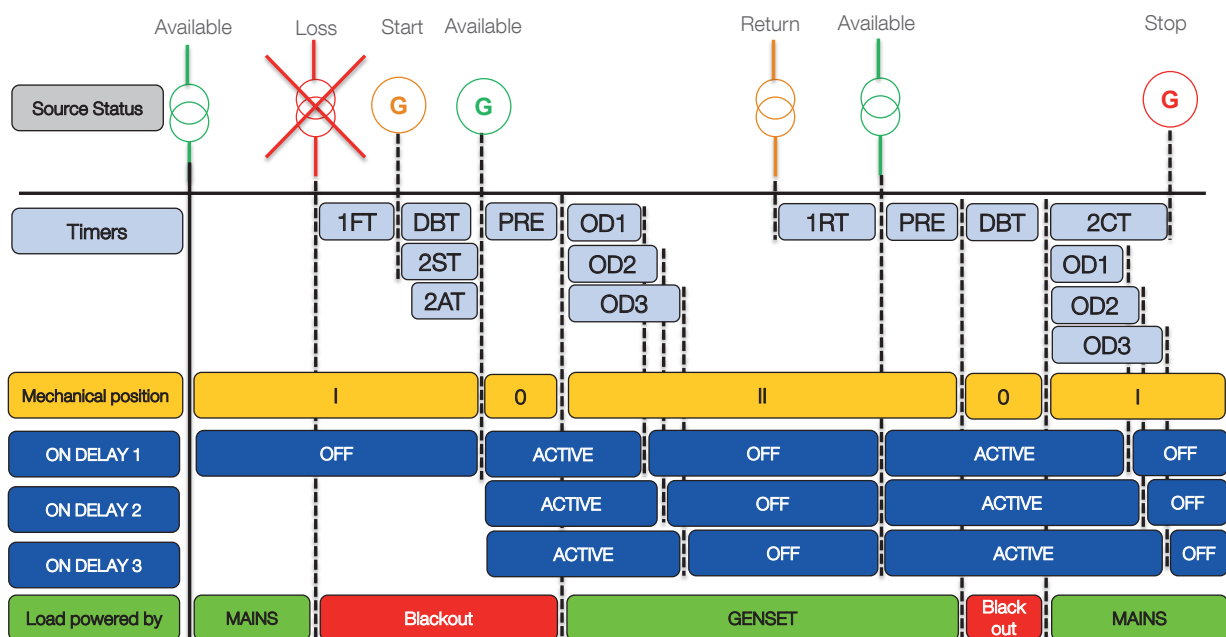



## 14.2.11. CYCLER

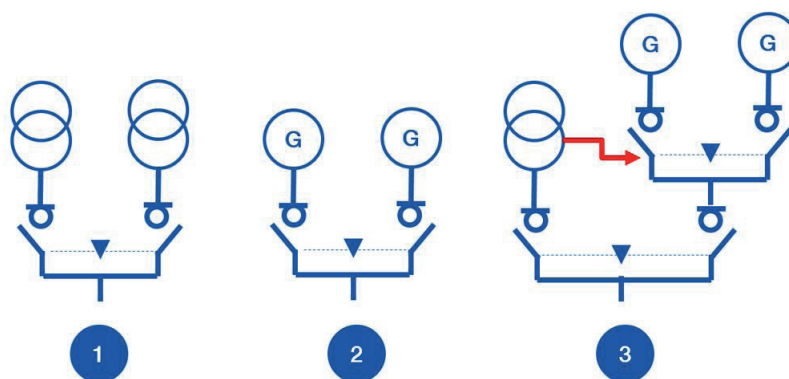

This function allows users in Main-Main (1) and Gen-Gen (2) to cycle periodically on each source.

Cycle functions are generally used to divide equally the use on the transformers or generators upstream or to change the sources to minimize electricity costs using night/day billing.

To activate this function controller must be in Main-Main Or Gen-Gen application.

CYCLER		ATyS C65
STATUS	◀ DISABLED ▶	
TRANSFER METHOD	AUTOMATIC	
S1 CYCLER DURATION (h)	0001	
S2 CYCLER DURATION (h)	0001	
TRANSFER TIME	00:00	
...		

Once the function is enabled users will be able to configure the transfer validation method (automatic or transfer at a specific time) the time of transfer (if specific time has been selected in transfer method) as well as the duration of a cycle.

In case of a loss of source during a cycle, the controller will switch to the available source and stay there until the lost source becomes available and the cycle is over.

The backup gen-gen function allows cycling between two gensets only when the input is active, this input usually comes from another ATS system or any other indicating that the primary source is lost (3).

To activate the backup gen-gen mode the controller must be in Gen-gen application, with an input configured to "BACKUP GENGEN", in backup mode the 24 V.d.c auxiliary supply is mandatory to keep the genset start signals inactive.

SETTING	OPTION	DESCRIPTION
STATUS	ENABLED, DISABLED	Option to activate or not the cycling function, application must be GEN-GEN or MAIN-MAIN to enable
TRANSFER METHOD	AUTOMATIC, SPECIFIC TIME	If AUTOMATIC is selected transfer will take place as soon as the set cycle duration is over. If specific time is selected transfer will take only at the time configured if the cycle duration is completed.
S1 CYCLER DURATION (h)	0-9999	Duration of a cycle for source 1
S2 CYCLER DURATION (h)	0-9999	Duration of a cycle for source 2
TRANSFER TIME	00:00 - 23:59	Time of the day at which the transfer will take place (only if SPECIFIC TIME has been set in TRANSFER METHOD)
BACKUP GEN GEN START MODE		
PRIOR SELECTION	PRIORITY SOURCE, FULL CYCLE, LEAST USED, ALTERNATE	"This setting is only active when the BACKUP GEN-GEN input has been programmed. It will determine which genset to start first in backup gen-gen mode: - PRIORITY SOURCE: genset on the source programmed as priority source - FULL CYCLE : If cycler is ENABLED, the genset which has not completed it's full cycle duration will start - LEAST USED : will start the genset with the least run time - ALTERNATE : will start the genset which was NOT the last to be active"

## 14.2.12. COMMIT

The commit function is used to force the transfer to the secondary source after loss of the priority source in the eventuality that source 1 returns before the transfer has been done.

See graphic below for COMIT function logic:

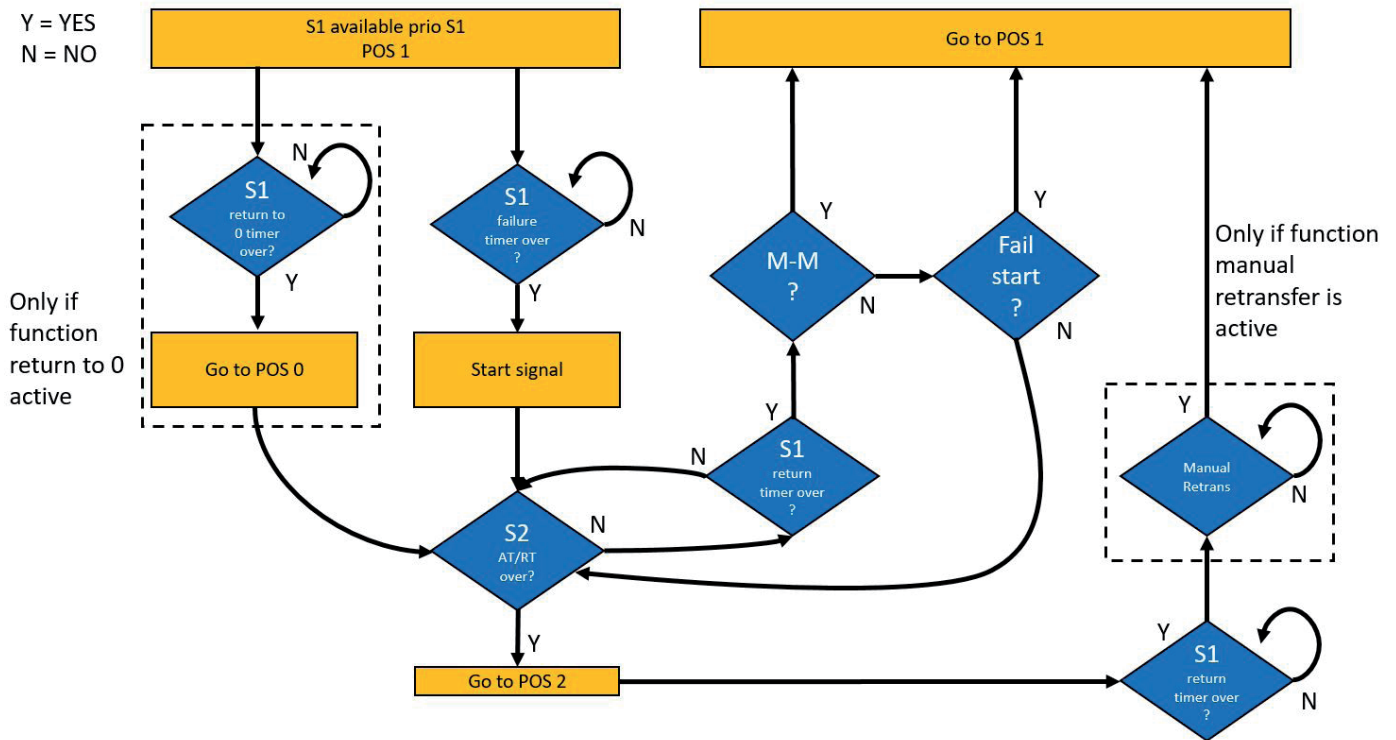

## 14.3. Maintenance Menu

The maintenance menu permits to perform service-reserved actions on the controller:

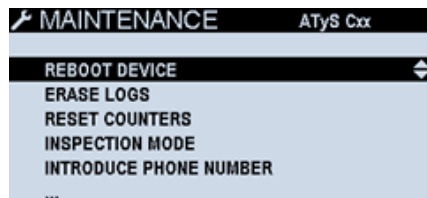

- Reboot device: permits a software reboot on the controller without erasing any information. A confirmation request will pop up when pressing OK on the function.

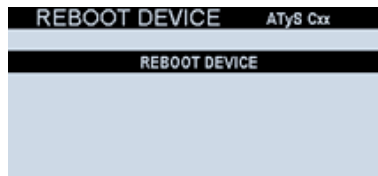

- Erase Logs: erases the event log or the alarm log. A second confirmation will be required.



- Reset counters: resets to 0 the counter values (switch, time in position, operational hours or genset statistics)

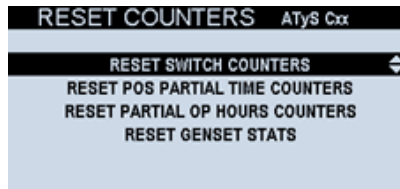

- Inspection Mode: after servicing the product, this menu can be used to add the last inspection date/time. This information can be consulted on the main menu / ABOUT section by all the users.



- Introduce phone number: a phone number can be introduced to appear on the ABOUT screen as the maintenance phone number, so in case there is an urgency, the operator in front of the controller can quickly check the phone number to make a call to the person in charge / supplier.

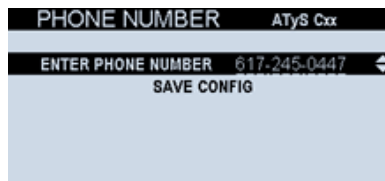

- Energy Backup (only on C65): the energy backup time can be set from 0 to 30 seconds. By default it is set to 15 seconds and it can preserve this time even after 8 years of use of the product.

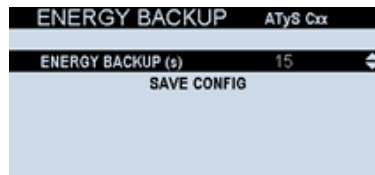

## 14.4. Configuration through EasyConfig System software

**EasyConfig System** is a software tool that permits to fully configure the ATyS C55/C65 and other Socomec products with a very intuitive interface and that permits also preparing configurations when not connected to the product, save preset configurations and loading them to the controller(s) when being in front of the product. This is very useful when many controllers have to be configured with (almost) the same settings.

How to configure the main parameters by using Easyconfig System software:

Connect via communications or USB to the controller, open the Easyconfig software and follow the different screens to set all the parameters.

You can download EasyConfig for free from the following link:

[https://www.socomec.com/easy-config-software\\_en.html](https://www.socomec.com/easy-config-software_en.html)



You can download the Instruction Manual on the following link:

[https://www.socomec.com/operating-instructions\\_en.html](https://www.socomec.com/operating-instructions_en.html)



# 15. MAINTENANCE



## 15.1. About the controller

All the main information about the controller can be directly found inside the ABOUT menu, accessible through the main menu of the controller:

i ABOUT		ATyS C65
PRODUCT TYPE	ATYS C65	
LAST INSPECTION	01/01/00 00:00	
SERIAL NUMBER	19102010011R6000066*	
FIRMWARE VERSION	1.0	
COMM ADDR	6	
MAINTENANCE TEL	+33 000 000 000	

- PRODUCT TYPE: Model of the product (ATyS C55 / ATyS C65 )
- LAST INSPECTION: This date is modified in the MAINTENANCE MENU / INSPECTION MODE by the service team by adding the new INSPECTION DATE after servicing the product for the first time. If there is no modification of this parameter, by default it will show "01/01/00 00:00"
- SERIAL NUMBER: Serial number of the product. The number can also be found on the top marking of the product as "N° S/N" followed by a number. This number might be asked by Socomec service team whenever technical support is required.
- FIRMWARE VERSION: Version of the controller firmware. This will only change in case of a product firmware upgrade, done by an authorised Socomec service team.
- COMMUNICATION ADDRESS: Modbus RTU communication address for the controller. It can be set through the wizard or inside the COMMUNICATION parameters (see chapter 11.1.6)
- MAINTENANCE TEL: This value is configurable inside the MAINTENANCE menu / INTRODUCE PHONE NUMBER option to integrate inside the ABOUT menu a phone number by the user related to the maintenance of the product (for example, Socomec's contact number or the maintenance manager in contact with the service team number).

Product references:

Part Number	Image	Description
1600 0055		ATyS C55 ATS Controller with mid-level functionalities
1600 0065		ATyS C65 ATS Controller with advanced functionalities

## 15.2. Faults management and Troubleshooting

There are several events that can cause a Fault on the controller. Unlike the alarms, the faults are not user-selectable, they will always be considered and actions will take place as follows:

FAULT	DESCRIPTION (CAUSE)	ACTIONS	ACKNOWLEDGE / CLEARED	FAULT LOG	POP-UP	FAULT LED	OUTPUT
Unexpected Transfer	The controller receives a feedback/return from the switch without sending any order (auto or manu). Also if loss feedback of current position.	Mode stays the same.	Can also be cleared through display or through RST - Reset Fault input.	Yes	Yes, "Unexpected Transfer"	BLINKS (priority)	FLT - Fault active
Failed to Transfer	Position not reached after an order sent by controller (auto or manu) or loss of feedback of the new source after sending a transfer command.	Mode stays the same. Controller will start retries.	Automatically cleared if the requested position is reached or cleared through display or through RST - Reset Fault input.	Yes	Yes, "Failed to transfer"	BLINKS (priority)	FLT - Fault active
Max operation per minutes reached	If the controller performs 10 operations in less than 1 minute (by default) (automatic or controlled/manual)	Mode stays the same. During a timer, the controller will not do or allow any operation.	Automatic after the 1 minute (configurable through software) (value is dynamic).	Yes	Yes, "Max operations per minutes reached"	FIXED (non-critical)	FLT - Fault active
Max password attempts reached	User tries to enter a profile password more than X times set in the maintenance menu (by default 10 attempts)	Mode stays the same. Can't enter any password during X time set in the maintenance menu (by default 2 minutes)	Automatic after the set timeout (maintenance mode).	Yes	Yes, "Max number of tries reached, please wait: X s"	FIXED (non-critical)	FLT - Fault active
Genset Failstart	Controller tries to start a genset (as configured) and after the genset start delay, the genset doesn't start (controller doesn't see the source on)	Mode stays the same. Genset start relay remains active unless other source is available.	Automatic if genset starts or if source is set as Main/Utility.	Yes	Yes, "Engine fail to start"	BLINKS (priority)	FLT - Fault active
External fault	If an input is selected as FTE - External Fault and becomes active	Switch goes to position 0 / center-off directly without timers and the mode is set to Partial Inhibit (genset starts if needed).	Input mustn't be active and reset by user is requested (by RST- Reset Fault input or through display.	Yes	Yes, "External fault"	BLINKS (priority)	FLT - Fault active
Unknown position	Loss of switch position input while no order was given or no position feedback after the start of a transfer	Mode stays the same	Auto-cleared if any position becomes active	Yes	Yes, "Unknown position"	BLINKS (priority)	FLT - Fault active

For faults with pop-up, the pop-up will be cleared when fault will be cleared or by pressing any button on the front face of the controller. The total number of faults logged on the controller is dynamic, as the total number of "faults + alarms" is 100 (not including the events, which are 3000 on C65 and 300 on C55) and uses a FIFO ordering.

To clear Faults through the display, it is possible inside the LOG/FAULTS menu with the option “PRESS OK TO CLEAR FAULTS”, using the configurator profile password. There is also a shortcut by holding the  button for 1,5s and validating on the pop-up that appears. If the fault is still active, it will be inside the log “in progress” but the fault LED and output will be off. If the faults are not active any more, they will be logged in the “history” log. This way to clear the fault will be automatically proposed by the controller through a pop-up:

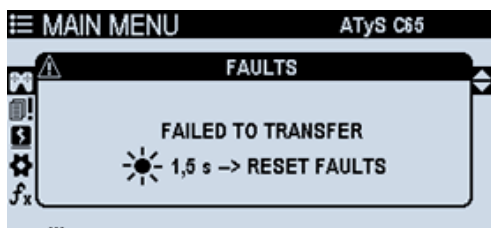

## 15.3. Maintenance of the controller

To clean the front face of the equipment, use a soft cloth with water and non-abrasive liquids.

The ATyS C55/C65 controller is conceived to be a maintenance free, fit and forget unit. However, it is recommended to perform visual inspections periodically on the device, checking the connections, that the display screen is functional and the LED using the lamp test button and ensuring the correct functioning with the switching device and with any possible associated software.

As a best practice, perform at least one full cycle with your equipment (solution with the controller + RTSE) every year.

There are no serviceable parts in the controller. In case of a malfunction, don't hesitate to contact Socomec and/or return the product for a replacement in case warranty is still valid. During conversations with Socomec, you might be asked for the model, firmware version or the serial number of the unit. This information can be found inside the ABOUT menu. If the controller screen is not functional, then use the labels and QR code on the back side of the controller to inform our service team.

### RTC Battery replacement



Depending on the working and environmental conditions conditions the battery will need to be replaced when the controller displays a message "RTC Low Battery". Should the time & date at power up be incorrect it will be time to replace the battery.

To do so:

1. Disconnect all terminals from the controller
2. Release the cover on the side of the controller containing the battery
3. Remove the old battery with an appropriate plastic tool
4. Place the new battery on the correct side (polarity) in the holder from the pcb and push with the finger until it reaches the position of the old one.
5. Put back the plastic cover on the side of the controller and pressure slightly until it perfectly fits.
6. Connect back the terminals to the controller
7. Power up and adjust time and date

For battery replacement, use a BR2032 coin-type cell.

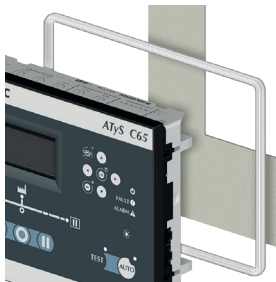
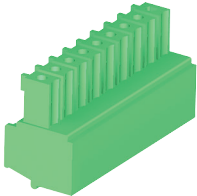
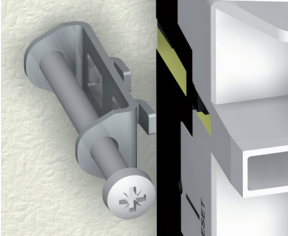
## 15.4. Spare parts

Part Number	Image	DESCRIPTION
1609 0001		IP65 silicon sealing gasket for door mounting in outdoors
1609 0002		Connector kit (including ATyS C55/65 but also ATyS FT/DT connectors that can be thrown away when using other technologies)
1609 0004		Controller mounting screws / Fixing clips (for door mounting) (kit of 4 units)
1609 0005		Controller mounting feet (for back plate mounting) (kit of 4 units)



## 15.5. Accessories and expansion modules

Part Number	Image	DESCRIPTION
4829 0140		DIRIS Digiware IO-10 for ATyS C65 4 Digital inputs + 2 Digital outputs expansion module A maximum of 6 modules can be connected to the controller
4829 0222		DIRIS Digiware M-70 communication gateway for Ethernet & Webserver
4829 0202		DIRIS Digiware D-70 communication gateway for Ethernet & Webserver and multi- product display
Consult Socomec		Current Transformers for ATyS C65

For the connection between the controller and the accessories and between modules, a RJ45 Digiware cable is needed. There are different sizes available:

LENGTH (M)	QUANTITY	REFERENCE
0.1	1	4829 0181
0.2	1	4829 0188
0.5	1	4829 0182
1	1	4829 0183
2	1	4829 0184
5	1	4829 0186
10	1	4829 0187
50 m reel + 100 connectors		4829 0185

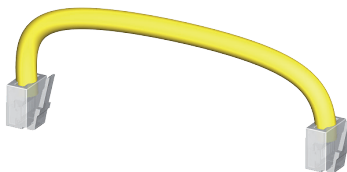

# 16. ANNEXES

## Annex 16 - 1. Wiring Diagrams

The bellow diagrams detail the connections of the ATyS C55/C65 with ATyS Switches as well as the generic wiring diagram for circuit breakers.

### 16.1.1. Connection diagram with ATYS d

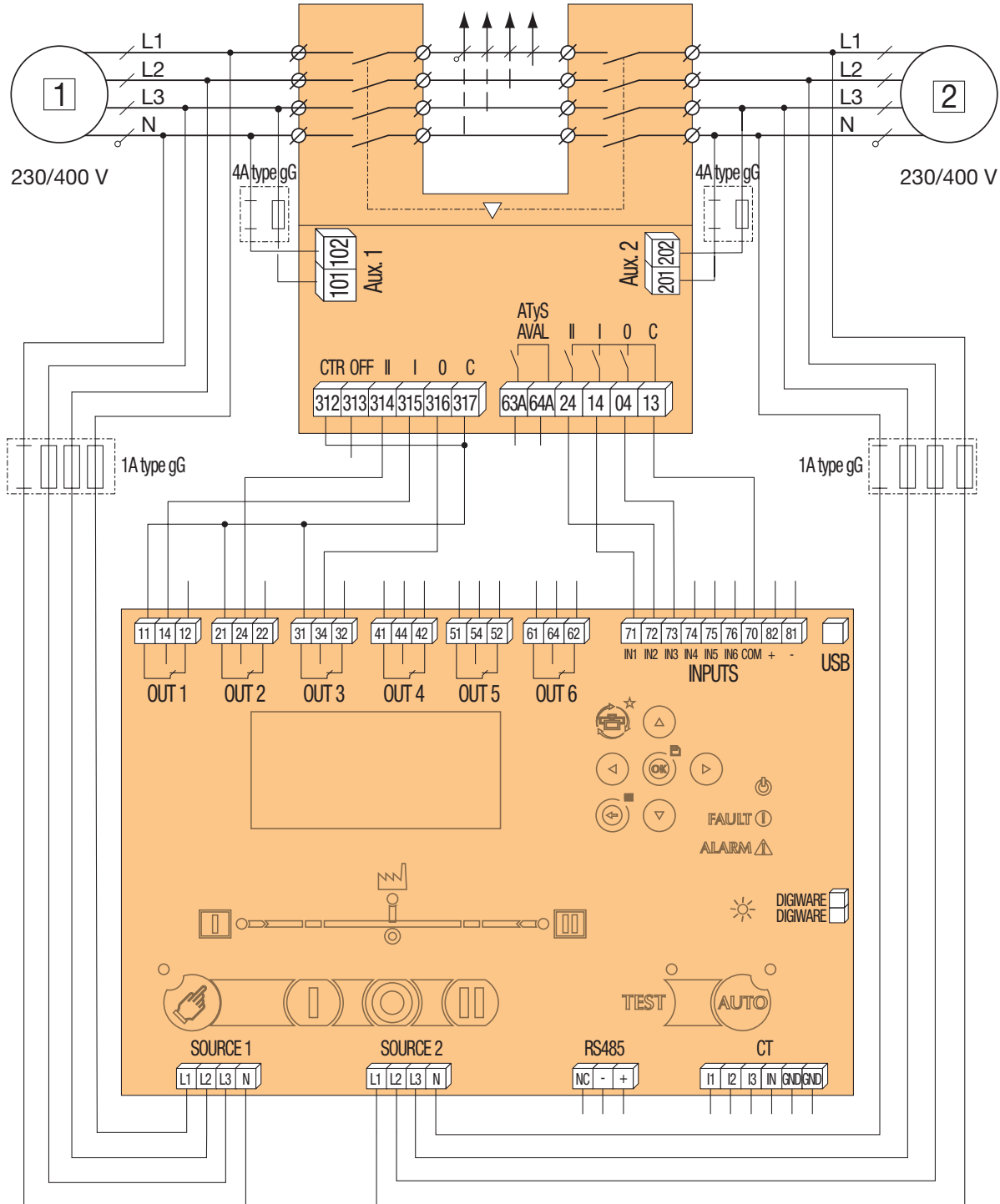

## 16.1.2. Connection diagram with Circuit Breakers

### 16.1.2.1. With mechanical interlock

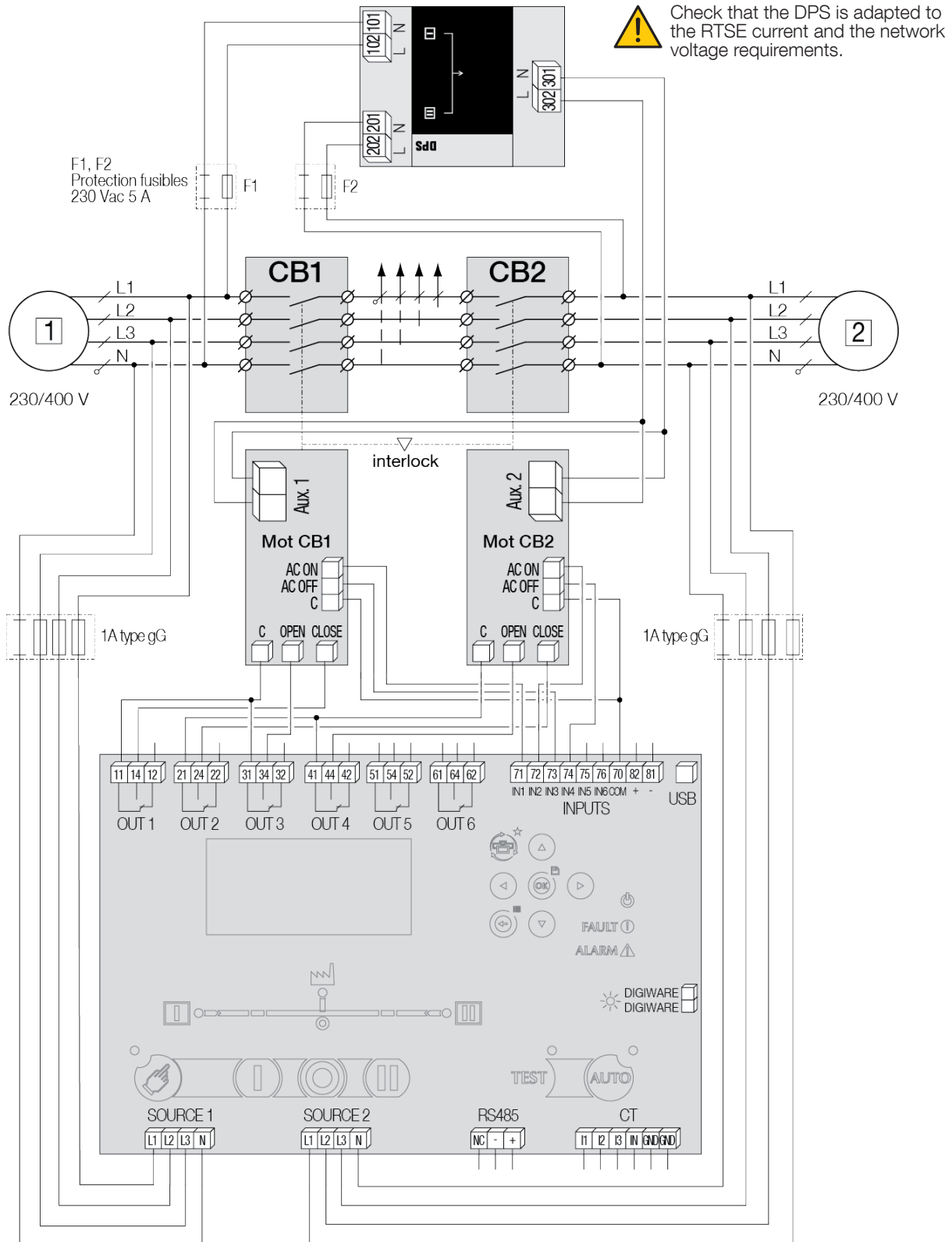

- Please consider Inputs and Outputs cabling are related to the configuration parameters. This diagram corresponds to the ATyS controller presets for the Circuit Breaker technology. The presets for each type on technology can be found in chapter "9.6.1. Command circuits", page 25.



**CAUTION !** Due to the numerous types of RTSE type CB (circuit breakers) available on the market, compatibility and specific wiring designs must be carried out and qualified by others.

### 16.1.2.2. With electrical interlock

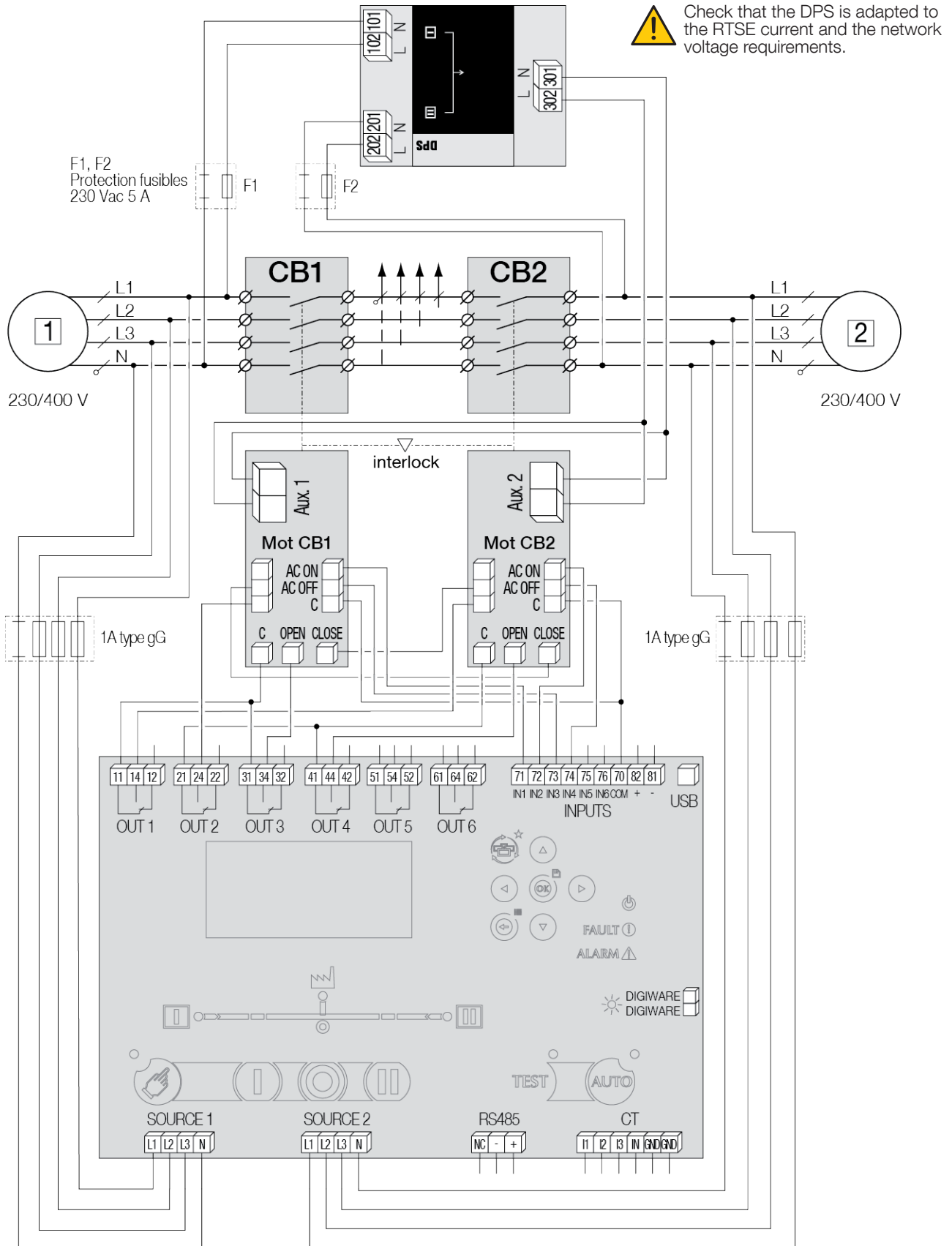

### 16.1.3. Connection diagram with ATyS dH

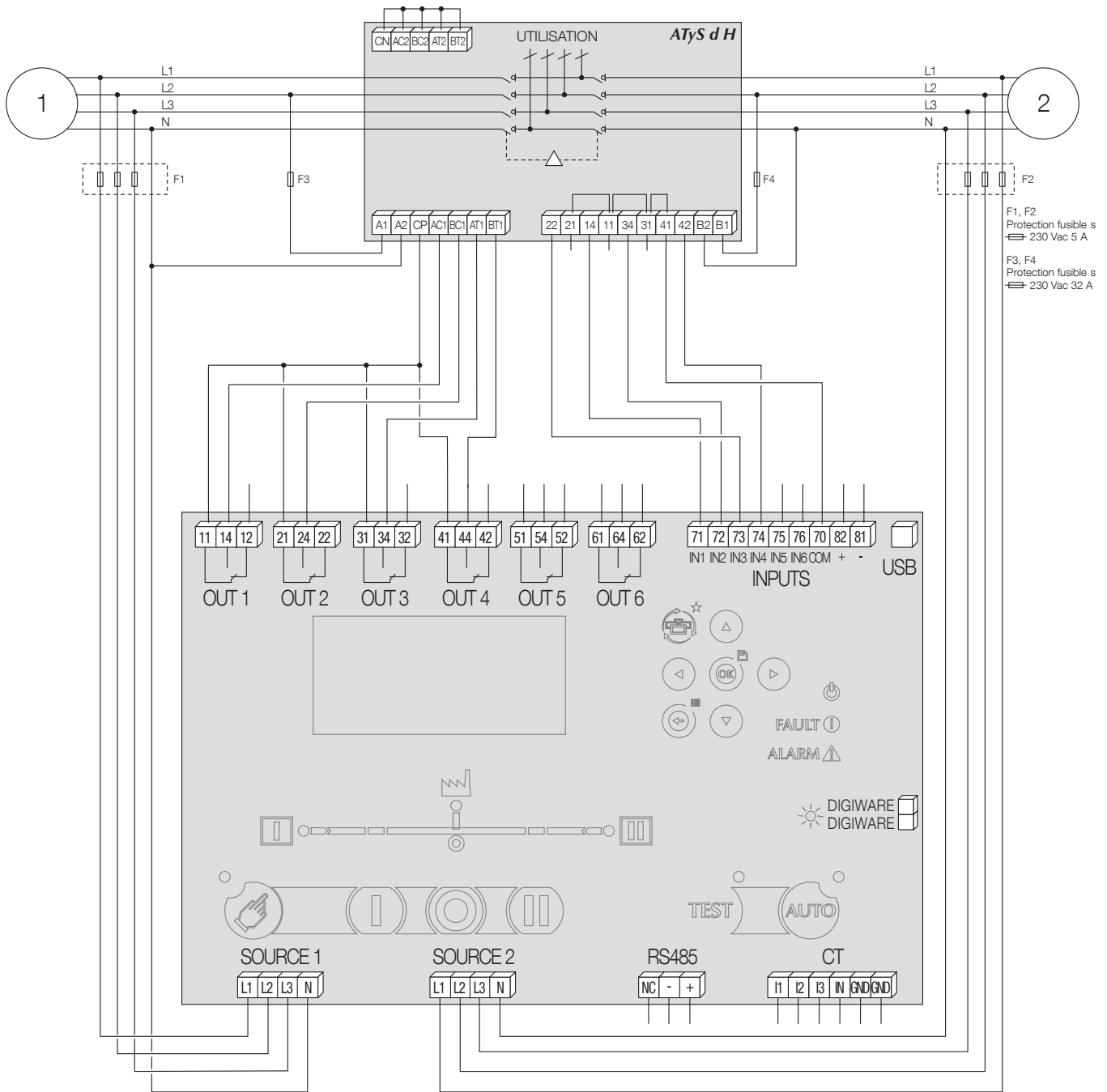

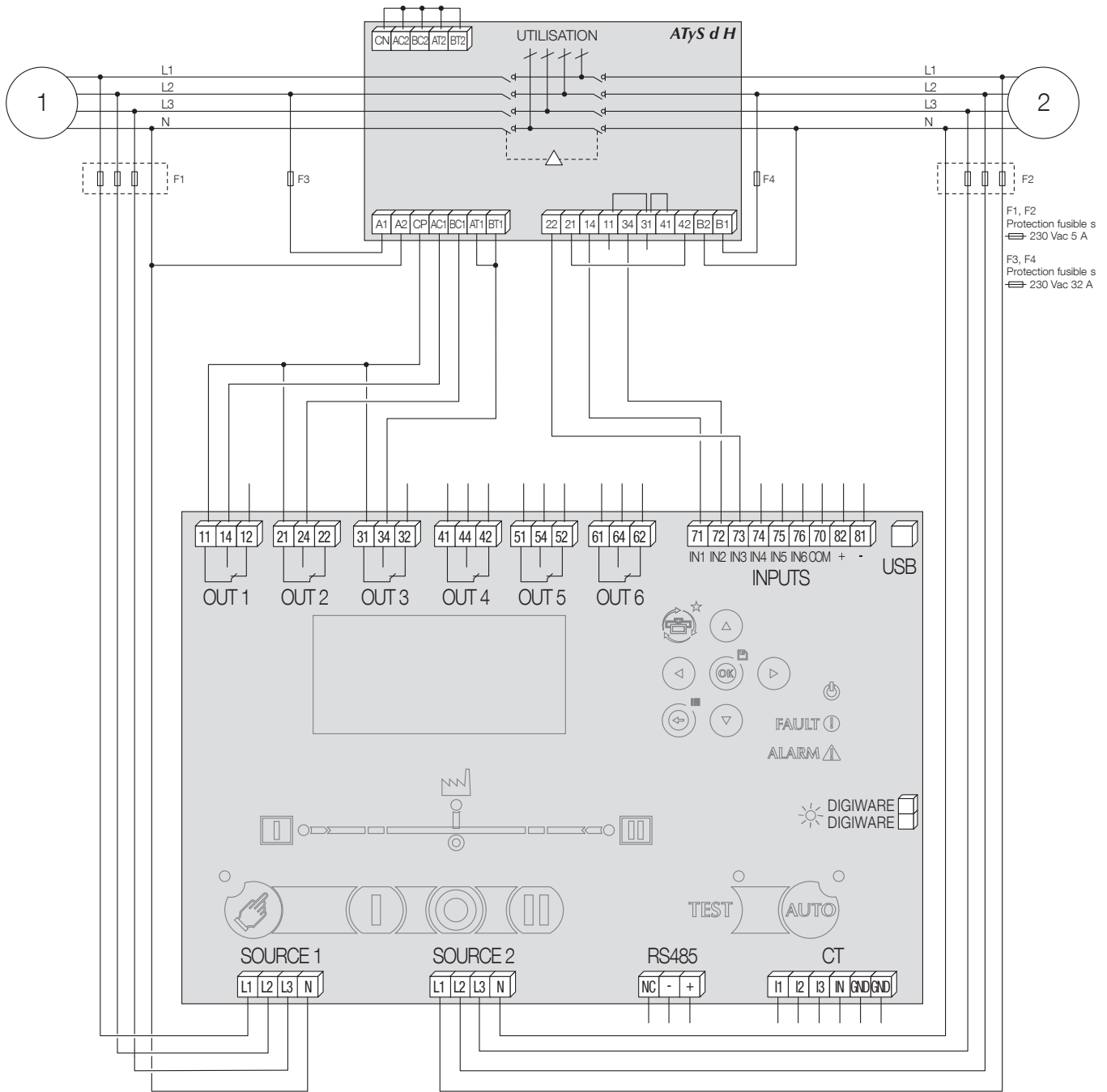

### 16.1.4. Connection diagram with ATyS dM

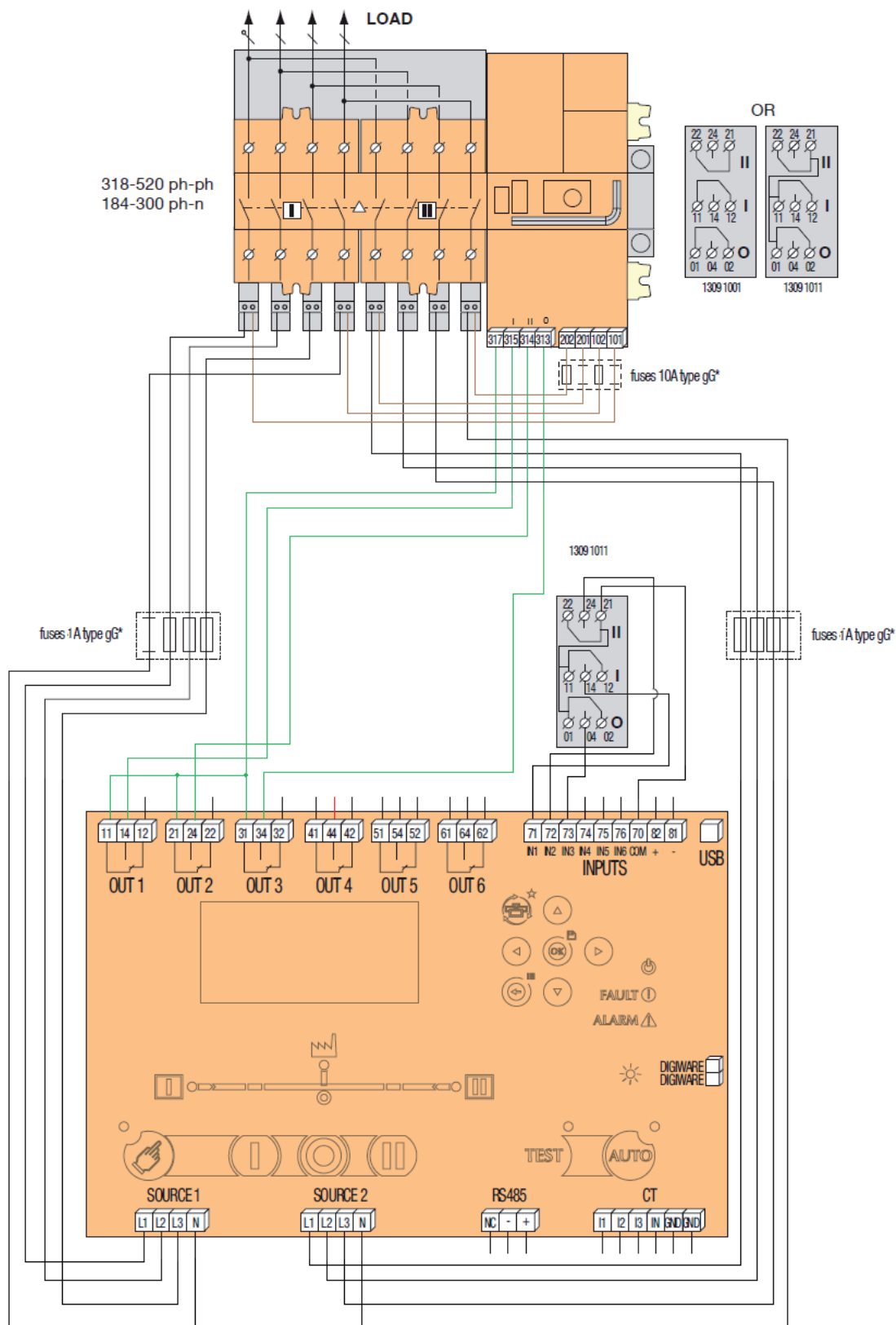

## Annex 16 - 2. Timers list

For more details on timer use see annexe "Annex 16 - 5. Operating sequences", page 96.



Note: please note that the number of timers available on C55 and C65 are not the same.

These options can be configured in the Parameters / Timers menu:

### OPERATION TIMERS

TRIGRAM (ECS)	TIMER	DESCRIPTION	SELECTABLE RANGE	BY DEFAULT
1FT	S1 FAILURE TIMER (s)	Source 1 Failure Timer: When source 1 is considered lost, 1FT is started. If source 1 is considered restored before the end of 1FT, the changeover sequence will not be engaged.	0-60sec	3sec
1RT	S1 RETURN TIMER (s)	Source 1 Return Timer: When source 1 returns, 1RT is started. At the end of 1RT, source 1 is then considered to be present. Should source 1 disappear before the end of 1RT, the changeover will not be carried out. In case the alternate source disappears during 1RT, a dynamic 3 second delay will override the 1RT time setting value. <b>⚠ NOTE:</b> this timer is only available if source 1 is a Utility, it is replaced by AVAILABILITY timer 1AT if source is a genset.	0-3600sec	180sec
2FT	S2 FAILURE TIMER (s)	Source 2 Failure Timer: When source 2 is lost, 2FT is started. If source 2 is restored before the end of 2FT, the changeover sequence is not started.	0-60sec	3sec
2RT	S2 RETURN TIMER (s)	Source 2 Return Timer: When source 2 returns, 2RT is started. At the end of 2RT, source 2 is then considered to be present. Should source 2 disappear before the end of 2RT, the changeover will not be carried out. <b>⚠ NOTE:</b> this timer is only available if source 2 is a Utility, it is replaced by AVAILABILITY timer 2AT if source is a genset.	0-3600sec	5sec
1AT / 2AT	S2/S1 AVAILABILITY TIMER (s)	Source (1/2) Available Timer: Stabilisation time delay for voltage and frequency on Source (1/2) . 1/2AT starts as soon as the source voltage is above the hysteresis value. Transfer to Source 1/2 may be done at the end of this time delay. <b>⚠ NOTE:</b> this timer is only available if source is a genset, it is replaced by RETURN timer 1RT / 2RT if source is a utility.	0-3600sec	180sec
DBT1/ DBT2 <sup>(1)</sup>	S1 or S2 DEAD BAND TIMER (s)	Dead Band Timer: This is the minimum electric dead time (blackout time) to respect when the source is lost or when transferring between source. This defines the minimum load supply downtime so as to allow residual voltages that may be generated by the load (such as motors) to decay.	0-20sec	3sec

(1) For the C55 there is only 1 DBT dead band timer, which will be applied for both sources.



## GENSET TIMERS

TRIGRAM (ECS)	TIMER	DESCRIPTION	SELECTABLE RANGE	BY DEFAULT
1CT / 2CT	S1/S2 GENSET COOLDOWN (s)	Source 1 or 2 (Genset) Cool Down Timer: Following a return to priority source sequence, the genset on backup source is kept running for the 1CT/2CT timer duration. This is intended to cool down the genset (off load) before switching off.	0-600sec	180sec
1ST / 2ST	S1/2 START TIMEOUT (s)	Source 1 or 2 Genset start timeout delay: This time delay is started as soon as the genset start signal is given. Should source 1 or 2 not become available after timer 1ST/2ST has elapsed a "FAIL START" error message is displayed on the product LCD.	0-600sec	30sec
EET1	GENSET TIMEOUT S1 (h)	S1 maximum reset timer - Battery Charger maximum Off Timer. This timer defines the minimum time that the Genset must be switched off to activate the output EES (Battery Charger Signal). This doesn't involve any transfer, it's just to charge the genset batteries.	0-1100h	168h
EET2	GENSET TIMEOUT S2 (h)	S2 maximum reset timer - Battery Charger maximum Off Timer. This timer defines the minimum time that the Genset must be switched off to activate the output EES (Battery Charger Signal). This doesn't involve any transfer, it's just to charge the genset batteries.	0-1100h	168h
EDT1	BATTERY CHARGE DURATION S1 (s)	S1 Run timer (for batt charger). The output EES will be deactivated after this duration and battery charge will stop.	0-9999s	1800s
EDT2	BATTERY CHARGE DURATION S2 (s)	S2 Run timer (for batt charger). The output EES will be deactivated after this duration and battery charge will stop.	0-9999s	1800s

 Note: in order to ensure a good operation, make sure that 1ST and 2ST timers are longer than 1AT and 2AT. Otherwise there will be a fault appearing on the screen saying "Fail to start". This is due to the fact that the genset will always take longer to become available.

## TEST ON LOAD TIMERS

TRIGRAM (ECS)	TIMER	DESCRIPTION	SELECTABLE RANGE	BY DEFAULT
TOT (lim/unlim)	TEST ON LOAD	Test on load limited/unlimited	-	UNLIMITED
TOT	TEST ON LOAD (s) - TIME / DURATION	Test On Load Duration Timer: This timer defines the On Load Test time. It starts counting when the Test is initiated. The return to the main supply takes place at the end of TOT. Note: TOT is configurable when TOT (LIM/UNL) above is set to LIM.	0-21600s	10s
T3T	TEST ON LOAD END (s)	Test On Load – End Delay Timer: This time delay starts counting at the end of TOT Timer. The return to the main supply takes place at the end of T3T time.	0-1800s	5s
E1T	EXTERNAL TEST ON LOAD PRE / BEFORE	External Order Test ON Load - Start Delay Timer. This time delay starts at the same time as the External On Load (EOL) order is received. At the end of this time delay, the Genset start order is activated. The load will be transferred to the Genset supply.	0-1800s	5s
E2T (lim/unlim)	EXTERNAL TEST ON LOAD	External Test on load limited/unlimited	-	UNLIMITED
E2T	EXTERNAL TEST ON LOAD (s) - TIME / DURATION	External Order Test On Load - Duration Timer: This timer starts counting when the Test is initiated. The return to the main supply may initiate at the end of E2T time. Note: E2T duration timer is configurable in the timers menu when at least 1 input is configured as EOL and with E2T (UNL/LIM) set to UNL.	0-21600s	10s
E3T	EXTERNAL TEST ON LOAD POST / AFTER	External Order Test On Load – End Delay Timer: This time delay starts counting at the end of E2T Timer. The return to the main supply takes place at the end of E3T time.	0-1800	5s

## TEST OFF LOAD TIMERS

TRIGRAM (ECS)	TIMER	DESCRIPTION	SELECTABLE RANGE	BY DEFAULT
TFT (lim/unlim)	TEST OFF LOAD	Test off load limited/unlimited	-	UNLIMITED
TFT	TEST OFF LOAD (s) - TIME / DURATION	Test Off Load - Duration Timer: This time delay defines the Off Load Test time. It starts counting when the Test is initiated. Note: TFT is configurable in the timers menu when TFT (LIM/UNL) above is set to LIM.	0-21600s	600s
E5T	EXT TEST OFF LOAD PRE / BEFORE (s)	External Order Test Off Load - Start Delay Timer. This time delay starts at the same time as the External off Load Test (EOF) order is received. At the end of this time delay, the Genset start order is activated. The load will not be transferred to the Genset supply.	0-1800s	5s
E6T (lim/unlim)	EXT TEST OFF LOAD	External Test off load limited/unlimited	-	UNLIMITED
E6T	EXT TEST OFF LOAD (s) - TIME / DURATION	External Order Test Off Load - Duration Timer: This timer starts counting when the Test is initiated.	0-21600s	600s
E7T	EXT TEST OFF LOAD POST / AFTER (s)	External Order Test On Load – End Delay Timer: This time delay starts counting at the end of E6T Timer. The Genset signal will switch at the end E7T.	0-1800s	5s

## SPECIFIC FUNCTIONS TIMERS

FUNCTION	TRIGRAM (ECS)	TIMER	DESCRIPTION	SELECTABLE RANGE	BY DEFAULT
In-phase Transfer	IPT	DWELL TIMER / IN-PHASE TIMER	In-phase Timer: During this timer the in-phase parameters should be inside the accepted window of values to perform an in-phase transfer.	0 - 5 sec	500ms
In-phase Transfer	IPD	DWELL TIMER RESET / IN-PHASE RESEARCH DELAY	In-phase Timer: During this timer the controller will monitor the synchronism between the 2 sources to perform an in-phase transfer when the parameters are ok during the configured dwell timer.	0-20min	3min
Load control	ELD	LOAD CONTROL Pre Transfer	Load control delay timer: If the output is used, the controller will send a signal to the load through the LOAD CTRL output the value of this timer (sec) before a transfer will take place.	0-9999s	5sec
Load control	ELR	LOAD CONTROL Post Transfer	Load control reset timer: If the output is used, the controller will open the output to finish the signal to the load, the value of this timer (sec) after a transfer takes place to an available source.	0-9999s	5sec
Return to 0	10T / 20T	S1 or S2 RETURN TO 0 (s)	Return to 0 timer: If no source available, time before going to 0 when "return 0" active from the source (S1 or S2)	0 - 10 sec	2s
Forced load shedding	LSD	LOAD SHEDDING PRE-TRANSFER TIMER (s)	Load Shedding - Time Delay (before transfer) Timer. This time delay corresponds to the time available to perform any load shedding operations downstream before the RTSE starts to changeover.	0-60s	4s
Forced load shedding	LSR	LOAD SHEDDING POST-TRANSFER TIMER (s)	Load Shedding - Time Delay (after transfer) Timer. This time delay corresponds to the time the load shedding output will remain active after retransferring to the priority source, before loading back the non-priority loads.	0-60s	1s
HVAC Compressor	DCT	HVAC COMPR. TIMER (s)	When going back to priority source position, first the associated output DCT (HVAC COMPRESSOR) contact (to shut down the compressor) before starting the transfer and when the switch reaches position, start a defined number of seconds timer before closing this output again. It avoids stressing the compressor.	0-3600s	20s

FUNCTION	TRIGRAM (ECS)	TIMER	DESCRIPTION	SELECTABLE RANGE	BY DEFAULT
Tripping action	CH1/CH2	CHARGING TIME (s)	Time needed to charge the breaker 1/2 spring mechanism, during this time new orders to transfer will be placed on hold, these timers will be bypassed if the breaker charged inputs are activated.	0-15	0
Load adding	PreODx	PRE TRANSFER TIMER (s)	Before transferring this all On delay outputs will be activated when this timer initiates. Transfer will only be allowed at the end of this timer	0-99	0
Load adding	OD1-OD7	ON DELAY TIMER 1-7 (s)	Time after transfer for which the ON DELAY output will be active (up to 7 timers).	0-3600	Timer number x20s
Cycler	1CY/2CY	S1/S2 CYCLE DURATION (h)	Duration of a cycle for a source, at the end of the cycle the controller will initiate a transfer based on transfer settings.	0-9999	1

## Annex 16 - 3. Input list

These options can be configured in the Parameters / I/O / Inputs menu:

TRIGRAM	INPUT NAME	DESCRIPTION	C65	C55
AC1	SWITCH IN POS.1 / BRK 1 CLOSED	Read position 1 from the RTSE	x	x
AC2	SWITCH IN POS.2 / BRK2 CLOSED	Read position 2 from the RTSE	x	x
AC0	SWITCH IN POS.0	Read position 0 from the RTSE	x	x
AC0A	SWITCH A S1 IN POS.0 / BRK1 OPEN	Read position 0 from the SWITCH on S1	x	x
AC0B	SWITCH B S2 IN POS.0 / BRK2 OPEN	Read position 0 from the SWITCH on S2	x	x
MAN	RTSE IN MAN	RTSE In Manual Mode: This input is connected to the switch to inform the controller that the switch is in maintenance mode (door is open for servicing). The controller commands will be inhibited but navigation through the menu and dashboards on the display are allowed. This situation will remain until the input is cleared. Screen will show the following message when the input is activated "INHIBIT MODE RTSE IN MANUAL"	x	x
LCK	PADLOCK	Product padlocked. Screen will show "INHIBIT MODE PRODUCT PADLOCKED" while the input is active. Controllers goes to Inhibit mode until input is cleared. The controller commands will be inhibited but navigation through the menu and dashboards on the display are allowed.	x	x
IEE	INH. GENSET SCH.	Inhibit Engine Exerciser: This input will inhibit the Engine Exerciser automatic functioning. All customized exercising programs will be bypassed and not take place whilst this input is active.	x	-
POP	RTSE AVAILABLE	Information coming from the RTSE to inform that the RTSE is operational.	x	x
PS1	GO TO POS.1	External order to go to pos 1 Position command only available if mode is in position CTRL. The last command received has priority.	x	x
PS2	GO TO POS.2	External order to go to pos 2 Position command only available if mode is in position CTRL. The last command received has priority.	x	x

TRIGRAM	INPUT NAME	DESCRIPTION	C65	C55
PS0	GO TO POS.0	External order to go to pos 0 Position command only available if the mode is in position CTRL. Command 0 has priority over commands I and II.	x	x
RT0	RETURN TO 0	Overrides the "Return to 0" function inside SPECIFIC FUNCTIONS	x	-
BLK	BLOCKED	Product blocked, meaning that the RTSE is blocked, can't move. The controller will go into Partial Inhibition (starting the genset if necessary) but not transferring. Message on the display "Product blocked"	x	x
TP1	TRIP BRK1	Protection on S1 has tripped	x	x
TP2	TRIP BRK 2	Protection on S2 has tripped	x	x
REC	AUTO/MANU	Places the controller in manual mode remotely (can be used to activate the use of inputs "go to position X").	x	x
EST	EMERGENCY SIGN.	Emergency off signal. Controller will pilot to go to position 0 (if any). CTRL will be disabled, AUTOMATIC mode will be off, genset won't be started, "Emergency Off" will be displayed on screen. If Lift/Elevator signal is enabled, its timers will be respected before giving the command to go to 0.	x	x
IPI	IN-PHASE INHIBIT	In-phase transfer inhibition: This input will disable the in-phase transfer function, so if the input is active it will disable the in-phase transfer between sources, allowing a transfer without taking into account the phase monitoring between sources.	x	-
IPB	IN-PHASE BYPASS	In-phase bypass: When this input is active (pulse), the switch will bypass the dwell time reset timer (sync-checking). This input can only be used when there is a in-phase checking already taking place. This input can only be taken into account after the In-phase delay timer is elapsed (DWEELL TIMER RESET / IN-PHASE RESEARCH)DELAY.	x	-
BCT	BYPASS TIMER	Bypass timer: Bypasses the current timer on the screen / first one of the list of timers running.	x	x
ELB	LOAD CTRL BYPASS	It will bypass the load control delay timer (ELD) when active, if the elevator function is active.	x	-
IS1	INHIBIT S1	Inhibits source 1. Transfer to the source is forbidden and if the load is on that source it will immediately be transferred to the opposite	x	-
IS2	INHIBIT S2	Inhibits source 2. Transfer to the source is forbidden and if the load is on that source it will immediately be transferred to the opposite	x	-
CH1	BREAKER 1 CHARGED	Gives feedback that the breaker mechanism is charged and ready to transfer.	x	x
CH2	BREAKER 1 CHARGED	Gives feedback that the breaker mechanism is charged and ready to transfer.	x	x
CTT	COMMIT	Activate the commite to transfer function when this input is active.	x	-
EGG	BACKUP GENGEN	Activates the backup Gen-gen mode if the application is set to "GEN-GEN"	x	x
CYC	CYCLER	Activates the cycler function	x	x
DIS1	BRK1 DISCONNECTED	Informs the controller that the breaker 1 is disconnected. When activated a pop-up will appear on the screen and automatic operation will be inhibited.	x	x
DIS2	BRK2 DISCONNECTED	Informs the controller that the breaker 2 is disconnected. When activated a pop-up will appear on the screen and automatic operation will be inhibited.	x	x
MS1	MTSE in position 1	Only for bypass technology indicates the the manual bypass switch is in position 1	x	-
MS0	MTSE in position 0	Only for bypass technology indicates the the manual bypass switch is in position 0	x	-
MS2	MTSE in position 2	Only for bypass technology indicates the the manual bypass switch is in position 2	x	-
WTH	Withdrawn	Only for bypass technology, indicates that the RTSE is withdrawn	x	-
CON	Connected	Only for bypass technology, indicates the the RTSE is connected	x	-

TRIGRAM	INPUT NAME	DESCRIPTION	C65	C55
AACK	ALARM ACKNOWLEDGE	Aknowleges the alarm programmed in alarm menu.		
-	NONE	INPUT NOT USED	x	x
INH	INHIBITION	Inhibition of the automatism. Mode inhibition (not automatic). CTRL is permitted. Genset won't start if the source is lost	x	x
INHp	PARTIAL INHIBITION	Inhibition of the automatism. Mode inhibition (not automatic). CTRL is permitted. Genset will start if the source is lost to ensure the supply of the controller, but it will not transfer.	x	x
INHt	TOTAL INHIBITION	Inhibition of the automatism. Mode inhibition (not automatic). CTRL is NOT permitted. Genset won't start if the source is lost	x	x
TON	TEST ON LOAD	Start test on load with dedicated test on load timers	x	x
TOF	TEST OFF LOAD	Start test off load with dedicated test off load timers	x	x
EON	EXT. LOAD	Remote on load test: If set to UNLIMITED, this order will start the cycle to transfer and the controller will not send an order to go back to preferred source until the signal is cleared. If set to LIMITED, a pulse on the input will start the test that will follow the E2T and other timers.	x	x
EOF	EXT. NO LOAD	Remote off load test: If set to UNLIMITED, this order will start the genset and stop the genset according to the external test off load configuration inside the parameters. If set to LIMITED, a pulse on the input will start the test that will follow the configured timers.	x	x
MRT	MANUAL RETRANS	Manual Retransfer to priority source (touching keypad or via INPUT) Remote transfer back to the priority source: This is the same function as "MANUAL RETRANSFER" cleared with the keypad. This variable in the PARAMETERS/SPECIFIC FUNCTIONS menu must be enabled to validate the operation through this input.	x	x
PRI	CHANGE PRIO	Changes the priority between sources	x	x
SS1	BYPASS STAB S1	Bypasses the stabilisation timer for S1 (S1 return timer)	x	x
SS2	BYPASS STAB S2	Bypasses the stabilisation timer for S2 (S2 return timer)	x	x
ALE	EXT ALARM	External alarm active. It will be logged in the alarm log as External Alarm and the Alarm LED will be active. The alarm will be In progress until input is cleared	x	x
FTE	EXT FAULT	External fault active. The product will transfer to position 0 / center off. CTRL is permitted. Mode will be inhibit. Genset will not start if source is lost. "External Fault will be displayed on screen". It will be logged in the fault log as External Fault and the Fault LED will be active. The fault will be In progress until input is cleared and fault reset.	x	x
MSR	PRIO TEST ON LOAD	EJP / Stay on "backup" source. Priority Test on Load. Order to stay in S2 even if the source is lost or unavailable.	x	x
OA1	FORCE S1 AVAIL.	Force Source 1 as Available	x	x
OA2	FORCE S2 AVAIL.	Force Source 2 as Available	x	x
OU1	FORCE S1 UNAVAIL.	Force Source 1 as Unavailable	x	x
OU2	FORCE S2 UNAVAIL.	Force Source 2 as Unavailable	x	x
RST	RST FAULT STATE	Fault Reset : This input may be used to reset a fault condition after the fault has been cleared. Faults may also be reset through communication or through the display.	x	x
LSB	BYPASS LSD	Bypasses the load shedding pre-transfer timer. Consequence is that load is considered as shed so transfer can take place. It'll immediately load shed.	x	-
CHP	CHANGE POSITION	Changes the position (if no priority defined). It partially inhibits when active. It goes back to Auto when cleared. It has to be a permanent maintained input, it can't be an impulse.	-	x

## Annex 16 - 4. Output list

These options can be configured in the "Parameters" > "I/O" > "INPUTS" menu:

TRIGRAM	OUTPUT NAME	DESCRIPTION	C65	C55
PO1	POS 1 ORDER / CLOSE BRK1	Switch position order to go to Source 1	x	x
PO2	POS 2 ORDER / CLOSE BRK2	Switch position order to go to Source 2	x	x
PO0	POS 0 ORDER	Switch position order to go to Position 0 (center off)	x	x
PA0	POS 0 ORDER S1 / OPEN BRK1	Switch position order to go to center-off (source 1)	x	x
PB0	POS 0 ORDER S2 / OPEN BRK2	Switch position order to go to center-off (source 2)	x	x
S1A	S1 AVAILABLE	Source 1 available: Output activated if source 1 is considered as available (see conditions of availability in the dedicated chapter of the manual).	x	x
S2A	S2 AVAILABLE	Source 2 available: Output activated if source 2 is considered as available (see conditions of availability in the dedicated chapter of the manual).	x	x
SCA	ANY SOURCE AVAIL.	Source 1 OR source 2 available: This output is activated when at least one source (S1 or S2) is available.	x	x
S1U	S1 UNAVAIL.	Source 1 unavailable: Output activated if source 1 is not considered as available (see conditions of availability in the dedicated chapter of the manual) or the source has been inhibited.	x	x
S2U	S2 UNAVAIL.	Source 2 unavailable: Output activated if source 2 is not considered as available (see conditions of availability in the dedicated chapter of the manual) or the source has been inhibited.	x	x
AC1	S1 CLOSED	Source 1 closed: This output has the function of an auxiliary contact. When the controller has the input from the switch to be in source 1, the output will be active. This also considers the case where with no real information about the position, the controller works in blind mode.	x	x
AC2	S2 CLOSED	Source 2 closed: This output has the function of an auxiliary contact. When the controller has the input from the switch to be in source 2, the output will be active. This also considers the case where with no real information about the position, the controller works in blind mode.	x	x
AC0	OFF POSITION	Both sources open (center-off): This output has the function of an auxiliary contact. When the controller has the input from the switch to be in center-off, with both switches open, the output will be active. This also considers the case where with no real information about the position, the controller works in blind mode.	x	x
LO1	S1 CLOSED + AVAIL	Load being supplied by source 1: When active, it indicates that source 1 is supplying the load and within the availability operating range. Source 1 has to reach the availability conditions.	x	-
LO2	S2 CLOSED + AVAIL	Load being supplied by source 2: When active, it indicates that source 2 is supplying the load and within the availability operating range. Source 2 has to reach the availability conditions.	x	-
LSC	FORCED SHEDDING	Active when transferring to source 2 to load shed loads by connecting this output to the open order on a circuit breaker or motorised switch. The function Forced Load Shedding has to be active on the specific functions menu.	x	-
FLT	FAULTS ACTIVE	At least 1 fault is active on the controller. Fault report	x	x
POP	PROD. OPERATIONAL	Information about the availability and correct functioning of the ATSE. The input POP should be enabled and linked to the availability output of the ATSE.	x	-
LCK	PRODUCT LOCKED	Report of padlocking of the product.	x	-
COP	CTRL OPERATIONAL	Controller operational: This output will be active while the controller is supplied, with no critical faults active and with the required conditions to perform an automatic operation when needed.	x	-
TOS	TEST ON LOAD	This output is activated if a load test (through the HMI) is ongoing.	x	-
EOS	EXT TEST ON LOAD	This output is activated if a load test (remote order) is ongoing.	x	-

TRIGRAM	OUTPUT NAME	DESCRIPTION	C65	C55
ROS	(EXT) TEST ON LOAD	This output is activated if any load test (either HMI or remote order) is ongoing.	x	x
PTS	SMART SHEDDING	Output active while the smart load shedding is active. To work, the "Smart Load Shedding" function has to be enabled inside the Specific functions menu.	x	-
EES	BATTERY CHARGER	Output to activate the battery charging. It is linked to the battery charger timers.	x	-
TPP	TRIP PARTIAL	Report of protection tripping in one of the sources.	x	-
TPT	TRIP TOTAL	Report of protection tripping on both sources.	x	-
IPT	IPT IN PROGRESS	In Phase Transfer ongoing.	x	-
CO1-CO6	COPY INPUT x	Active when the corresponding input will be active	x	-
EEA	SCHEDULER ACTIVE	This output will be active while any of the programs for the Engine exerciser are active. The settings of the exerciser parameters can be configured in the dedicated menu.	x	-
ELV	LOAD CONTROL	Load control signal output. It should be linked to the load in order to load shed before transferring and reactivate the load after transfer.	x	-
ARO	ALARM REPORT	This alarm output will be active in the case that one of the alarms set in the Alarms menu is active and the option to use the output to report the alarm is enabled.	x	x
DCT	HVAC COMPRESSOR	When going back to principal source position the contact will become active prior to starting the transfer (to shut down the compressor), then the transfer will take place and then after reaching the opposite source, a timer defined in the specific functions menu will elapse before deactivating this output again. It avoids stressing the compressors in HVAC chillers.	x	-
-	NONE	OUTPUT NOT USED	x	x
GS1	GENSET S1 START	Genset start/stop output. Only available on OUT 5 when the source is a generator (when configured as Genset/Genset) or on OUT 6 (when configured as Main/Genset with priority on S2).	x	x
GS2	GENSET S2 START	Genset start/stop output. Only available on OUT 6 when the source is a generator.	x	x
AUD	CRIT. ALM. ACTIVE	Output active when an alarm with the criticality CRITICAL is active	x	x
PHI	PHASE INVERSION	Output activated if the phase rotation measured is different from the one configured in APPLICATION	X	-
OD1-OD7	ON DELAY	Outputs linked to the "on delay timers"	X	X
ARO	ALM REPORT	Reports the alarm configured in the alarm menu.		
PRL	bypass	Bypass only, output report to signal that the bypass is in parallel mode (bypass and ATSE active).	X	-
TST	bypass	Bypass only, output report to signal that the bypass is in test mode.	X	-
EMG	bypass	Bypass only, output report to signal that the bypass is bypassed by emergency manual switch.	X	-
NRM	bypass	Bypass only, output report to signal that the bypass is bypassed by normal manual switch.	X	-

 Note: position orders cannot be used with the OUT 5 and OUT 6 (latching relays). The latching relays can take up to 2 seconds between opposite orders (NO to NC or NC to NO) and for added security when starting a genset will change state based on the timers or when the backup power is exhausted.

ANNEXE 16 - 5.1. MAIN-GENSET applications

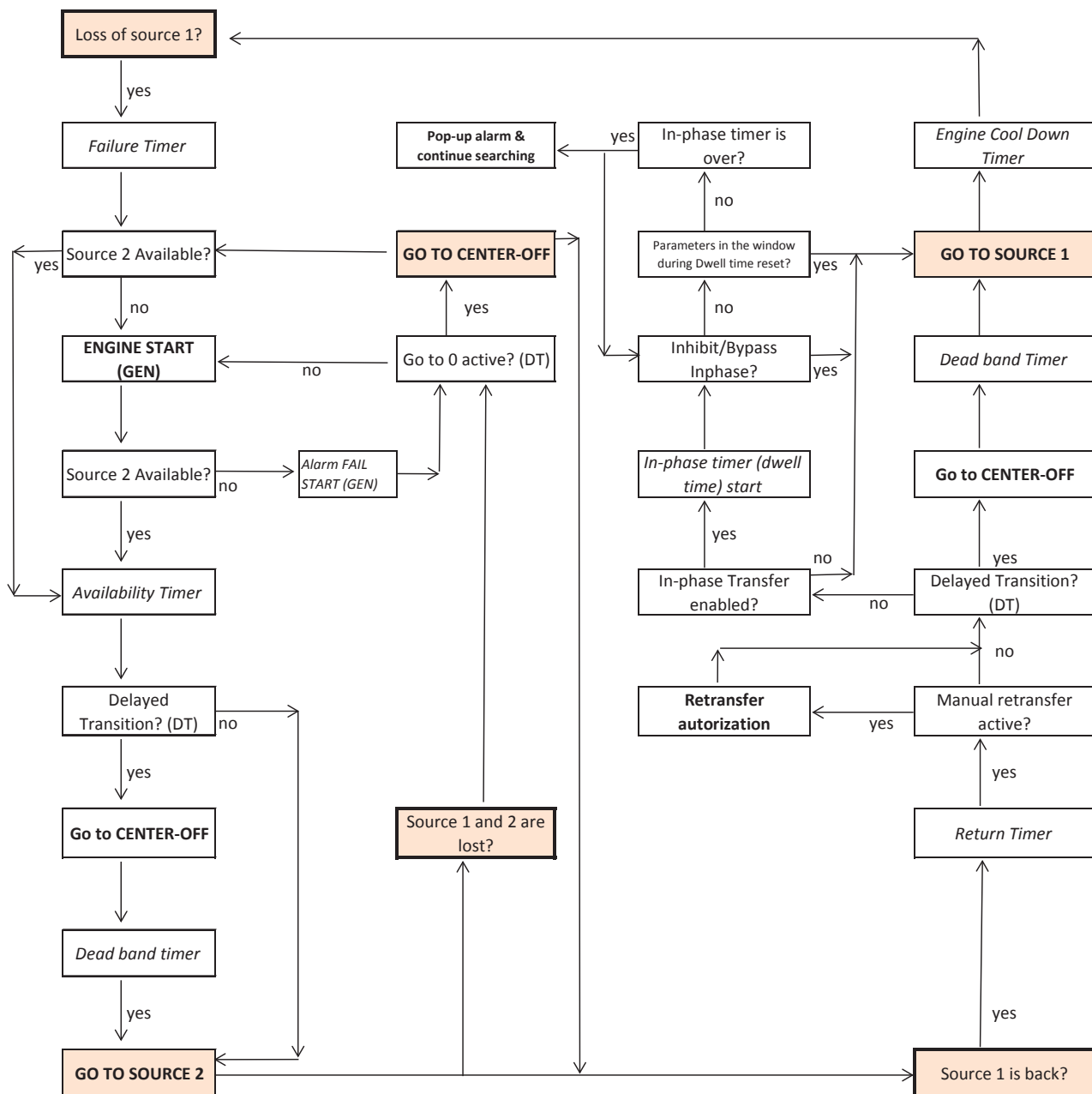



# Annexe 16 - 5.2. MAIN-MAIN Applications

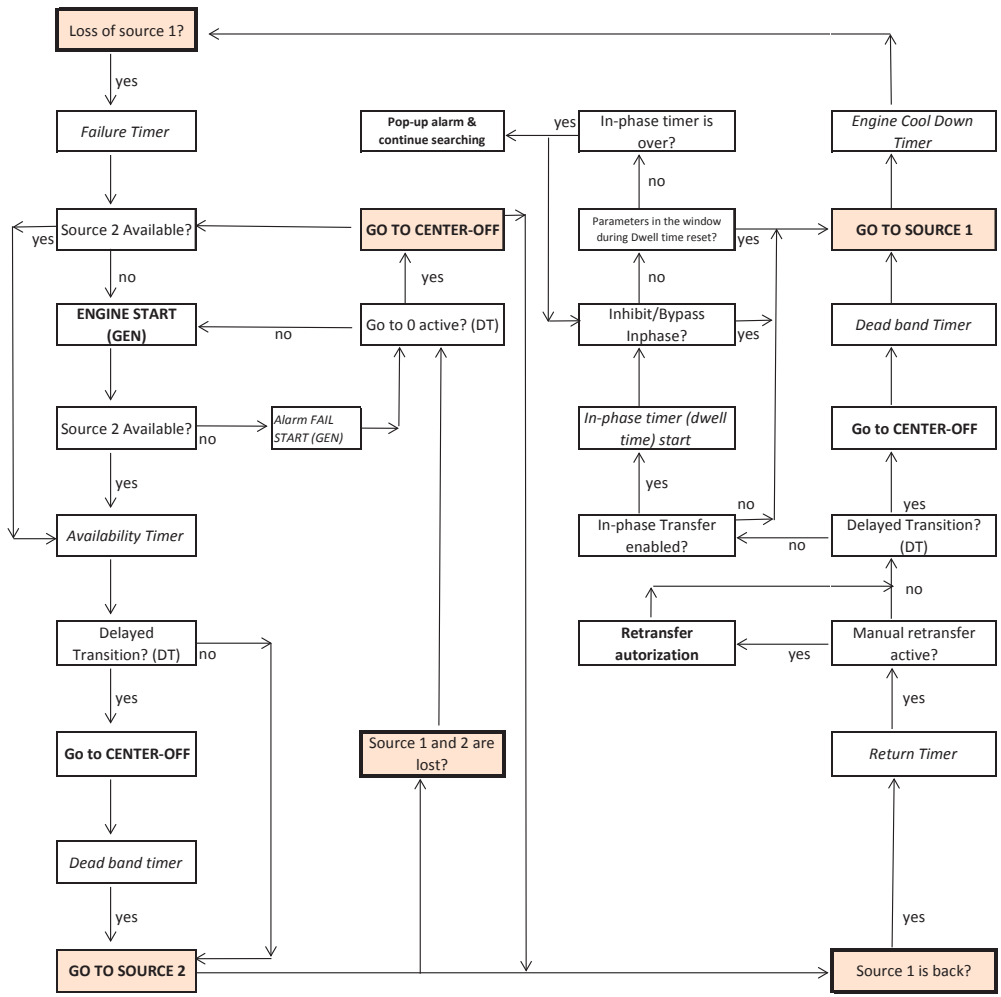

## Annex 16 - 6. ATyS C55/C65 Technical characteristics

### MECHANICAL FEATURES

Casing type	Fitted on a door (160x220) or back-plate
Case material	PC (Polycarbonate)
Protection degree	IP65 front panel /IP30 without gasket/ IP20 rear panel
Screen resolution	350x160 pixels – 8 lines of text
Weight	1085gr (controller without spare parts)

### AC POWER

Rated voltage	120/208/230/240/277/400/480
Operating limits	110-480VAC (+-20%)
Frequency	50-60Hz +-10%
Drawn/Dissipated power	<10W
Recommended fuses	1A gG

### DC POWER

Rated battery voltage	12-24VDC +/-20%
DC Aux supply for IO modules	24VDC
Reverse polarity protection	yes
Maximum drawn current	3A peak <10ms
Recommended fuses	1A gG

### VOLTAGE SENSING

Ue max. Rated voltage	480Vac
Ui (according 60947-1)	600Vac
Measuring range limits	50-576Va
Frequency range limits	45-66Hz
Measurement type	True RMS (TRMS)
Sample rate	9,6kHz
Measurement input impedance	6MΩ
Accuracy (V, U)	0,5%
Accuracy (f)	0,1%

### CURRENT MEASUREMENT (WITH EXTERNAL CURRENT TRANSFORMERS (ONLY C65))

Ie rated current (secondary)	Negative
Measuring range	6A max
Measurement type	True RMS (TRMS)
Permanent thermal limit	5A max
Current Accuracy	1%
Power Accuracy	2%
Active Energy Accuracy	1%



### DIGITAL INPUTS



Input type	1A or 5A
Input current	2,3mA at 24Vdc
Low input signal	Let input floating for low signal
High input signal	Link input with common to impose High level
Input signal delay	<200ms

OUTPUTS OUT 5-6	
Output type	latching / form C relay
Operating time	<30ms
Contact type	Volts free configurable NO/NC
Rating	AC1 8A 277Vac 50/60Hz AC15 2A 277Vac 50/60Hz DC1 5A 24Vdc
OUTPUTS OUT 1-4	
Output type	Non-Latching type
Operate time	<30ms
Contact type	Volts free configurable NO/NC
Rating	AC1 8A 277Vac 50/60Hz AC15 2A 277Vac 50/60Hz DC1 5A 24Vdc
RTC	
Battery type	Coin type cell (BR2032)
Battery voltage	3V
Battery lifetime (Average, depends on usage conditions)	6 years
RS485	
Interface type	2 to 3 half duplex wires
Protocol	MODBUS RTU
Baudrate	programmable 1200-115200 bps
Function	Configuration and data reading
Isolation	Functional
Maximum distance	1200m @9600 baud 200m @115200 baud
Termination	internal 120 ohms (selectable DIP switch)
DIGIWARE BUS (ONLY C65)	
Function	Connection between ATyS C65 and external modules
Cable type	Specific cable with RJ45 connections
ENVIRONMENTAL SPECIFICATIONS	
Ambient operating temperature	-30° ... +70°C
Storage temperature	-40° ... +70°C
Operating humidity	55°C / 95% HR
Operating altitude	<2000m
Vibrations	IEC 60947-1
Shocks	shocks according to Annexe Q IEC 60947-1
EMC classification	Class A+B
INSULATION / OVERVOLTAGE CAT.	
Impulse V withstand	Uimp=4kV. Test = 8kV between sources/6kV between phases
Installation overvoltage category	OVC III
Degree of pollution	Pollution degree 3
USB	
Connection	USB 2
Type	Type B Micro USB
Protocol	Modbus RTU on USB

MECHANICAL CHARACTERISTICS	
Height*length*depth	240x180x64
Weight	1085gr
EVENT RECORDER	
Capacity	3000 events (only C65, 300 for C55) + 100 alarms
Data storage	non-volatile memory
TYPE TESTS L'ENSEMBLE DES ESSAIS CEM SONT DÉCRITS DANS LA SEQUENCE 4 947-1	
Electrostatic Discharge Immunity - Air	8kV (B)
Electrostatic Discharge Immunity - Direct	4kV (B)
Radiated RF Immunity	10V/m
Electrical Fast Transient / Burst Immunity	2kV power access, 1kV signal access
Surge Immunity	1kV diff
Conducted RF Immunity	10Vrms
Radiated RF Emmision	Class B
Conducted RF Emmision	Class B
CASE	
Fire reaction of housing and cover	self-extinguishing UL94-V0
SERVICE LIFE COMPONENTS	
MTBF	>100yr

# Annex 16 - 7. Full menu architecture

MENU	SUBMENU 1	SUBMENU 2	SUBMENU 3
<b>DASHBOARD</b>			
 (NOT IN MENU ACCESS WITH DASHBOARD BUTTON)	MIMIC	STAT.	
		MET.	
		INFO	
	STATUS	STAT.	
		SYNC	
	METERING	SYS	
		I	
		V	
		U	
		F	
	POWER AND ENERGY*	SYS	
		P	GRAPH
		Q	GRAPH
		S	GRAPH
		PF	GRAPH
		EA	
		ER	
		ES	
	TIMERS	RUN	BYPASS TIMER
		S1	
		S2	
		OPT	
		TOX	
EOX			
ALARMS	ACT	GO TO ALARM	
	FIN	GO TO ALARM	
I/O	IN		
	OUT		
	E. IN		
	E. OUT		
MAINTENANCE	ALX	GO TO CONF	
<b>CONTROL</b>			
 OPERATOR PASSWORD NEEDED DEFAULT 4000	MODE / POSITION	MODE	
		CHANGE POSITION	
		GENSET SOURCE 1	
		GENSET SOURCE 2	
	TEST	TEST ON LOAD	
TEST OFF LOAD			
MANUAL RETRANSFER	PRESS OK FOR MANUAL RETRANSFER		
<b>LOG</b>			
 PWD: 4000	EVENT LOG		
	EVENT BY DATE*		
	ALARM LOG	IN PROGRESS	
PWD: 1000	FAULT LOG	HISTORY	
		IN PROGRESS	
		HISTORY	
		PRESS OK TO RESET FAULTS	
<b>STATISTICS</b>			

MENU	SUBMENU 1	SUBMENU 2	SUBMENU 3
 PWD: 4000	CYCLE		
	OPERATION		
	OPERATING HOURS		
	SOURCE 1		
	SOURCE 2		
	GENSET 1		
	GENSET 2		
	BREAKER		
	BYPASS		
<b>GENSET SCHEDULER</b>			
 GENSET SCHEDULER PWD: 4000	GENERAL PARAMETERS	GENSET IDLE TIMEOUT (MIN)	
	CUSTOM 1	TYPE SET	
		PERIODIC SCHEDULE	
		TEST DURATION (S)	
		START DATE	
		START TIME	
	CUSTOM 2*	TYPE SET	
		PERIODIC SCHEDULE	
		TEST DURATION (S)	
		START DATE	
	CUSTOM 3*	START TIME	
		TYPE SET	
		PERIODIC SCHEDULE	
		TEST DURATION (S)	
	CUSTOM 4*	START DATE	
		START TIME	
PERIODIC SCHEDULE			
TEST DURATION (S)			
	START DATE		
<b>PARAMETERS</b>			

MENU	SUBMENU 1	SUBMENU 2	SUBMENU 3	
 PWD: 1000	NETWORK	AUTODETECT.		
		SETUP	NETWORK TYPE	
			NOMINAL VOLTAGE	
			NOMINAL FREQUENCY	
			PHASE ROTATION	
			PHASE ROTATION CHECK	
			VT USED	
			VT PRIMARY	
		VT SECONDARY		
		APPLICATION	SWITCH TECHNOLOGY	
			APPLICATION TYPE	
			SOURCE 1 NAME	
			SOURCE 2 NAME	
			SOURCE PRIORITY	
			LOGIC	
			TEST ON LOAD PRIORITY	
			EXT TEST ON LOAD PRIO	
			RETRY NUMBER	
			RETRY DELAY (MS)	
		PULSE LENGTH (MS)		
		OPERATING RANGE S1	S1 OVERVOLTAGE FAIL (%)	
			S1 OVERVOLTAGE RESTORE (%)	
			S1 UNDERVOLTAGE FAIL (%)	
			S1 UNDERVOLTAGE RESTORE (%)	
			S1 UNBALANCE FAIL (%)	
			S1 UNBALANCE RESTORE (%)	
			S1 OVERFREQUENCY FAIL (%)	
			S1 OVERFREQUENCY RESTORE (%)	
			S1 UNDERFREQUENCY FAIL (%)	
			S1 UNDERFREQUENCY RESTORE (%)	
		OPERATING RANGE S2	S2 OVERVOLTAGE FAIL (%)	
			S2 OVERVOLTAGE RESTORE (%)	
			S2 UNDERVOLTAGE FAIL (%)	
	S2 UNDERVOLTAGE RESTORE (%)			
	S2 UNBALANCE FAIL (%)			
	S2 UNBALANCE RESTORE (%)			
	S2 OVERFREQUENCY FAIL (%)			
	S2 OVERFREQUENCY RESTORE (%)			
	S2 UNDERFREQUENCY FAIL (%)			
	S2 UNDERFREQUENCY RESTORE (%)			
	LOAD*	LOAD STATUS		
		LOAD TYPE		
		INOM		
LOAD NAME				
CT PRIMARY				
CT SECONDARY				
NEUTRAL CT PRIMARY				
NEUTRAL CT SECONDARY				
LINE I1 WAY				
LINE I2 WAY				
LINE I3 WAY				
LINE I4 WAY				



MENU	SUBMENU 1	SUBMENU 2	SUBMENU 3
 PWD: 1000	DISPLAY	SCREEN	LANGUAGE
			INTENSITY
			TIMEOUT (S)
		DATE AND TIME	DATE FORMAT
			DATE SEPARATOR
			DATE
		LED CONFIG*	TIME
			X LED FUNCTION
			X LED COLOR
			X LED BEHAVIOR
			X LED REPORT TYPE
			X LED REPORT IDX
			Y LED COLOR
			Y LED BEHAVIOR
			Y LED REPORT TYPE
			Y LED REPORT IDX
		OPTIONS	TEST BUTTON USE
			LAMP TEST DURATION (S)
			POPOP DISPLAYED
		CHANGE PRODUCT NAME	ATS NAME:
		SCREENSAVER TEXT	TEXT POLICE
LINE 1 TEXT			
LINE 2 TEXT			
LINE 3 TEXT			
LINE 4 TEXT			
PREVIEW			
	DEFAULT LOGO		



MENU	SUBMENU 1	SUBMENU 2	SUBMENU 3
 PWD: 1000	TIMERS	OPERATION	S1 FAILURE (S)
			S1 RETURN (S) / S2 AVAILABLE (S)
			S1 DEADBAND (S)*
			S2 FAILURE (S)
			S2 RETURN (S) / S2 AVAILABLE (S)
			S2 DEADBAND (S)*
		DEAD BAND (S) (ONLY C55)	
		GENSET SOURCE 1	S1 GENSET COOLDOWN (S)
			S1 START TIMEOUT (S)
			GENSET TIMEOUT S1 (H)
			BATT CHARGE DURATION S1 (S)
		GENSET SOURCE 2	S2 GENSET COOLDOWN (S)
			S2 START TIMEOUT (S)
			GENSET TIMEOUT S2 (H)
			BATT CHARGE DURATION S2 (S)
		TESTS ON LOAD	TEST ON LOAD
			TEST ON LOAD (S)
			TEST ON LOAD END (S)
			EXT TEST ON LOAD PRE (S)
			EXT TEST ON LOAD
			EXT TEST ON LOAD (S)
		TESTS OFF LOAD	EXT TEST ON LOAD POST (S)
			TEST OFF LOAD
			TEST OFF LOAD (S)
			EXT TEST OFF LOAD PRE (S)
			EXT TEST OFF LOAD
			EXT TEST OFF LOAD (S)
EXT TEST OFF LOAD POST (S)			

MENU	SUBMENU 1	SUBMENU 2	SUBMENU 3
 PWD: 1000	I/O	INPUTS	INPUT1
			INPUT2
			INPUT3
			INPUT4
			INPUT5
			INPUT6
			INPUT 1 TYPE
			INPUT 2 TYPE
			INPUT 3 TYPE
			INPUT 4 TYPE
			INPUT 5 TYPE
			INPUT 6 TYPE
		OUTPUTS	OUTPUT1
			OUTPUT2
	OUTPUT3		
	OUTPUT4		
	OUTPUT5		
	OUTPUT6		
	OUTPUT 1 TYPE		
	OUTPUT 2 TYPE		
	OUTPUT 3 TYPE		
	OUTPUT 4 TYPE		
	OUTPUT 5 TYPE		
	OUTPUT 6 TYPE		
	EXTERNAL I/O DETECTION*		
	EXTERNAL I/O CONFIG*	LIST OF AVAILABLE IO10 MODULES	
	COMMUNICATION	MODBUS ADDRESS	ADDRESS
		RS458 MODBUS	BAUDRATE
STOP			
PARITY			
DIGIBUS COMM*		BAUDRATE	
		STOP	
DIGIWARE MODE*	PARITY		
	MODE		

MENU	SUBMENU 1	SUBMENU 2	SUBMENU 3
 PWD: 1000	ALARMS	MEASURE ALARMS CONFIG*	ALARM ID
			STATUS
			CATEGORY
			SOURCES
			PARAMETERS
			UPPER THRESHOLD
			LOWER THRESHOLD
			HYSTERESIS (%)
			ACK METHOD
			INPUT TYPE
			ACK INPUT
			OUTPUT TYPE
			OUTPUT REPORT
			CRITICITY
		MAINTENANCE ALARMS CONFIG	ALARM ID
			STATUS
			ALARM TYPE
			UPPER THRESHOLD
			ACK METHOD
			ACK INPUT
			OUTPUT TYPE
			OUTPUT REPORT
			CRITICITY
			ALARM ID
		COMBINATION ALARMS CONFIG*	STATUS
			CRITICITY
			LOGIC
			ALARM 1 TYPE
			ALARM 1 INDEX
			ALARM 2 TYPE
			ALARM 2 INDEX
			ACK METHOD
			ACK INPUT
			OUTPUT TYPE
			OUTPUT REPORT
			ALARM ID
			STATUS
			LOGICAL ALARMS CONFIG
		LOGICAL INPUT	
		ACK METHOD	
		INPUT TYPE	
		ACK INPUT	
		OUTPUT TYPE	
		OUTPUT REPORT	
CRITICITY			
ALARM ID			
STATUS			
SYSTEM ALARMS CONFIG	INPUT TYPE		
	ACK METHOD		
	ACK INPUT		
	OUTPUT TYPE		
	OUTPUT REPORT		
	CRITICITY		

MENU	SUBMENU 1	SUBMENU 2	SUBMENU 3
 PWD: 1000	PASSWORD	CHANGE OPERATOR PWD	
		CHANGE CONFIG PWS	
		CHANGE MAINTENANCE PWD	
	WIZARD	FULL WIZARD STARTS	
<b>SPECIFIC FUNCTIONS</b>			
 PWD: 1000	MANUAL RETRANSFER	MANUAL RETRANSFER	
	INPHASE TRANSFER*	STATUS	
		DELTA VOLTAGE (V)	
		DELTA FREQUENCY (HZ)	
		DELTA ANGLE (°)	
		IPT TIMER (MS)	
		IN PHASE RESEARCH DELAY (S)	
		FAIL TO SYNC OPT	
	RETURN TO 0	RETURN TO 0	
		S1 RETURN TO 0 (S)	
		S2 RETURN TO 0 (S)	
	LOAD CONTROL*	STATUS	
		PRE TRANSFER TIMER (S)	
		POST TRANSFER TIMER (S)	
	FORCED LOAD SHEDDING*	STATUS	
		PRE TRANSFER TIMER (S)	
		POST TRANSFER TIMER (S)	
	SMART LOAD SHEDDING*	S1 AUTO LOAD SHED	
		S2 AUTO LOAD SHED	
		S1 AUTO LOAD SHED RESTORE	
		S2 AUTO LOAD SHED RESTORE	
	POWER UP IN AUTO	POWER UP IN AUTO	
	DBT TIMER IN CTRL*	DBT TIMER IN CTRL	
	HVAC COMPRESSOR*	STATUS	
		HVAC COMPRESSOR TIMER (S)	
	TRIPPING ACTION	SWITCH	
		TRIPPING ACTION	
		OP MODE AFTER TRIP	
		CHARG. TIME STATUS	
		CHARGING TIME (S)	
	LOAD ADDING	STATUS	
PRE TRANSFER TIMER (S)			
ON DELAY TIMER 1 (S)			
ON DELAY TIMER 2 (S)			
ON DELAY TIMER 3 (S)			
ON DELAY TIMER 4 (S)*			
ON DELAY TIMER 5 (S)*			
ON DELAY TIMER 6 (S)*			
ON DELAY TIMER 7 (S)*			
CYCLER	STATUS		
	TRANSFER METHOD		
	S1 CYCLER DURATION (H)		
	S2 CYCLER DURATION (H)		
	TRANSFER TIME		
COMMIT TO TRANSFER*	PRIO SELECTION		
COMMIT TO TRANSFER*	COMMIT TO TRANSFER		

**MAINTENANCE**

MENU	SUBMENU 1	SUBMENU 2	SUBMENU 3	
 PWD: 1010	REBOOT DEVICE	REBOOT DEVICE		
	MAX OPERATION	MAX OPERATION DELAY (MIN)		
	ERASE LOGS	RESET ALARM LOG RESET EVENT LOG		
	RESET COUNTERS	RESET SWITCH COUNTERS		
		RESET POS PARTIAL TIME COUNTERS		
		RESET PARTIAL OP HOURS COUNTERS		
		RESET GENSET 1 STATS		
		RESET GENSET 2 STATS		
		RESET BYPASS COUNTER		
		RESET BREAKER 1 COUNTER RESET BREAKER 2 COUNTER		
	INSPECTION MODE	DATE		
		TIME		
INTRODUCE PHONE NUMBER	ENTER PHONE NUMBER			
ENERGY BACKUP	ENERGY BACKUP			
<b>ABOUT</b>				
 (NO PWD)	PRODUCT NAME			
	LAST INSPECTION			
	SERIAL NUMBER			
	FIRMWARE VERSION			
	COMM ADDR			
	MAINTENANCE TEL			

All the menus with "\*" are only available for ATyS C65.

## Annex 16 - 8. Communications table

Find your product Modbus communication registers online at :  
[www.socomec.com](http://www.socomec.com)



---

CORPORATE HQ CONTACT:  
SOCOMECSAS  
1-4 RUE DE WESTHOUSE  
67235 BENFELD, FRANCE

---

[www.socomec.com](http://www.socomec.com)



549866C

 **socomec**  
Innovative Power Solutions